

# Heritage Specific Plan



September 2019  
City of Redlands, CA





# HERITAGE SPECIFIC PLAN

SEPTEMBER 2019



Prepared For:  
***City of Redlands***  
35 Cajon St.  
Redlands, CA 92373



Applicant:  
***Griffin Residential***  
110 N. Lincoln Ave., Suite 100  
Corona, CA 92882



Prepared By:  
***KTGY Group, Inc.***  
17911 Von Karman Ave., Suite 200  
Irvine, CA 92614

This page is intentionally left blank.

# TABLE OF CONTENTS

## **1 Introduction**

---

1.1	Purpose of the Specific Plan .....	1-1
1.2	Authority and Format of the Specific Plan .....	1-1
1.3	Project Description .....	1-3
1.4	Project Setting .....	1-5
1.5	Specific Plan Area .....	1-5
1.6	Relationship to the City’s General Plan .....	1-5
1.7	Project Objectives .....	1-5

## **2 Development Regulations**

---

2.1	Purpose and Intent .....	2-1
2.2	Permitted Uses .....	2-1
2.3	Development Standards .....	2-2

## **3 Design Guidelines**

---

3.1	Purpose and Intent .....	3-1
3.2	Neighborhood Design Components .....	3-1
3.3	Architectural Guidelines .....	3-2
3.4	Landscape Guidelines .....	3-7
3.5	Open Space Guidelines .....	3-12
3.6	Entry Treatments .....	3-13
3.7	Community Walls & Fences .....	3-15

## **4 Infrastructure**

---

4.1	Purpose and Intent .....	4-1
4.2	Circulation .....	4-1
4.3	Infrastructure .....	4-4

## **5 Implementation**

---

5.1	Purpose and Intent .....	5-1
5.2	Development Review Process .....	5-1
5.3	Specific Plan Modifications and Amendments .....	5-2
5.4	Variances .....	5-3
5.5	Program of Implementation Measures .....	5-3
5.6	General Plan Consistency .....	5-5



# LIST OF EXHIBITS

- Exhibit 1.1, Land Use Plan ..... 1-4
- Exhibit 1.2, Regional Location ..... 1-7
- Exhibit 1.3, Local Vicinity ..... 1-8
- Exhibit 1.4, Specific Plan Area (APN's) ..... 1-9
- Exhibit 1.5, Existing General Plan Land Use Designation ..... 1-10
- Exhibit 1.6, Proposed General Plan Land Use Designation ..... 1-11
- Exhibit 1.7, Zoning Designation ..... 1-12
- Exhibit 2.1, Conceptual Lot Layout ..... 2-4
- Exhibit 3.1, Conceptual Landscape Master Plan ..... 3-9
- Exhibit 3.2, Conceptual Entry Treatment ..... 3-14
- Exhibit 3.3, Community Wall & Fence Plan ..... 3-16
- Exhibit 4.1, Circulation Master Plan ..... 4-2
- Exhibit 4.2, Infrastructure Master Plan ..... 4-5
- Exhibit 5.1, Tentative Tract Map ..... 5-4

# LIST OF TABLES

- Table 2.1, Development Standards ..... 2-3
- Table 3.1, Plant Pallete ..... 3-11

This page is intentionally left blank.



# 1

## INTRODUCTION

### 1.1 Purpose of the Specific Plan

---

The Heritage Specific Plan (hereafter referred to as “Specific Plan” or “Project”) provides a detailed description of the proposed land uses, infrastructure and implementation requirements for future improvements on the site located in the City of Redlands. The design guidelines contained in this document will assist in creating architectural themes and landscape character. The development standards establish the permitted uses, setbacks and general development criteria. The Specific Plan will be adopted by resolution and serve as the zoning for the Specific Plan area.

This Specific Plan is intended to serve the following purposes:

- Promote quality development consistent with the goals and policies of the City of Redlands General Plan.
- Provide for comprehensive planning that assures the orderly development of the site in relation to its surroundings.
- Assure appropriate phasing and financing for circulation, streetscape, domestic water, urban runoff, flood control facilities, and sewer improvements.
- Establish development regulations that permit residential uses, provide pedestrian connections, and allow the flexibility for future improvements to be phased over time.
- Develop a plan that is economically feasible and that can be implemented based on existing and anticipated future economic conditions.
- Provide for the creation of an exciting, energetic, cohesive development that establishes a strong “sense of place.”

### 1.2 Authority and Format of the Specific Plan

---

The State of California Legislature has established the authority and scope to prepare and implement specific plans. The State requires that all cities and counties in California prepare and adopt a comprehensive General Plan for the physical development of their areas of jurisdiction. To implement the policies described in the General Plan, regulating programs need to be adopted (i.e., zoning ordinances, subdivision ordinances, building and housing codes, etc.).

California State law authorizes cities with complete General Plans to prepare and adopt specific plans (Government Code Section 65450 – 65457). Local planning agencies

or their legislative bodies may designate areas within their jurisdiction as areas for which a specific plan is “necessary or convenient” (Government Code Section 65451).

Specific plans are intended to serve as bridges between the local General Plan and individual development proposals. Specific plans contain both planning policies and regulations, and may combine zoning regulations, capital improvement programs, detailed development standards, and other regulatory requirements into one document, which are designed to meet the needs of a specific area.

This Specific Plan has been created through the authority granted to the City of Redlands by the California Government Code, Sections 65450 through 65453. This Specific Plan has been prepared in accordance with the provisions of the California Government Code, which stipulate that a specific plan contain text and diagrams that specify the following:

### **Land Use**

The specific plan should specify the distribution, location, and extent of the uses of land, including open space, within the area covered by the plan. This discussion is included in *Chapter 2* of this Specific Plan.

### **Design Standards**

The specific plan should include standards and criteria by which development will proceed. The Heritage Specific Plan includes landscape, architectural, and sustainable design guidelines in *Chapter 3, Design Guidelines*, of this Specific Plan.

### **Public Facilities**

The specific plan should show the proposed distribution, location, extent, and intensity of major components of public and private transportation, sewage, water, drainage, solid waste disposal, energy, and other essential facilities located within the area covered by the plan and needed to support the land uses described in the plan. This discussion is included in *Chapter 4* of this Specific Plan.

### **Implementation Measures**

The specific plan should include a program of implementation measures, including regulation, programs, public works projects, and financing measures. This discussion is included in *Chapter 5, Implementation*, of this Specific Plan.

### **General Plan Consistency**

The specific plan should include a statement of the relationship of the specific plan to the General Plan. This discussion is included in *Chapter 5, Implementation*, of this Specific Plan.

All future development plans, tentative parcel and/or tract map(s), and/or other similar entitlements for the Specific Plan area shall be consistent with the regulations set forth in this Specific Plan and with all other applicable City of Redlands regulations. Furthermore, all regulations, conditions, and programs contained herein shall be deemed separate, distinct, and independent provisions of the Heritage Specific Plan. In the event that any such provision, standard, or clause is held invalid or unconstitutional, the validity of all remaining provisions, standards, and clauses of this Specific Plan shall not be affected.

## 1.3 Project Description

---

The Heritage Specific Plan project is a planning effort of 37.2 acres initiated by the developer in the City of Redlands. The purpose is to guide future development of an abandoned citrus grove located in the northern portion of the City. Planned future development has been made viable by the construction of the 210 Freeway 1/3-mile to the west and the on/off ramps located on W. San Bernardino Ave. Once developed, the Project will provide a new source of tax revenue to the City, utilize predominately disturbed land, and will serve the City's residential needs while creating a quality development.

The Specific Plan is designed with the surrounding land uses in mind as depicted on *Exhibit 1.1, Land Use Plan*. The new planned community includes approximately 207 single-family one and two-story detached homes that will be wood-framed with concrete slab-on-grade floors. The planned development encompasses property located within the East Valley Corridor Specific Plan which will be amended to remove this area out of that specific plan (No. 40) and into the Heritage Specific Plan.

The new community will have a unique identity based on its physical features and public amenities. The neighborhood will be built-out with housing targeted at a variety of family sizes, couples, and ages. In all, a maximum of 207 dwelling units, with associated underground utilities, may be constructed in Heritage. The community will build-out at an overall gross density of approximately 5.7 dwelling units per acres.

Heritage will include housing types in a community setting that reflect the aesthetic charm and neighborhood structure reminiscent of traditional Southern California towns. A comprehensive sidewalk and trail system with connections to the public realm are planned throughout the project. This system includes landscaped nodes that connect the corners of the square-shaped property to the public street network; W. Pioneer Ave., Texas St., and W. San Bernardino Ave. Such connections will allow for a walkable community and the ability for potential students to walk to Citrus Valley High School.

In addition, the street network will lead to an open space area at the center of the community. This publicly accessible space will include a mix of passive uses including, but not limited to, picnicking areas, shade structure(s), playgrounds, gardens, seating areas, informal play areas, and attractive landscaping.

# Exhibit 1.1, Land Use Plan



Source: KTG Group, Inc.

N. T. S.

## 1.4 Project Setting

---

Regionally, the City Redlands is located in the southwestern portion of San Bernardino County in the largely undeveloped East Valley Corridor. Redlands is bisected by the 10-Freeway and is primarily surrounded by the developed cities of Loma Linda, San Bernardino, and Highland. The Specific Plan area encompasses 37.2 acres within the northern portion of the City of Redlands. *Exhibit 1.2, Regional Location*, depicts the location of the Project Site from a regional perspective.

In the local vicinity, the site is located approximately 1/3-mile east of the 210 Freeway and across the street from Citrus Valley High School. The project is generally bound by W. Pioneer Ave. to the north, Texas St. to the east, W. San Bernardino Ave. to the south, and an adjacent land owner to the west. *Exhibit 1.3, Local Vicinity*, shows the project site location within a local context.

## 1.5 Specific Plan Area

---

The Specific Plan area consists of four separate parcels, totaling 37.2 acres. The Assessor Parcel Numbers (APNs) and acreage of each of the parcels within the Specific Plan area are depicted on *Exhibit 1.4, Specific Plan Area*.

## 1.6 Relationship to City's General Plan

---

The Redlands General Plan is a “blueprint” that documents the City’s vision for the future and provides goals, policies, and implementation measures that can be utilized by City staff and decision makers to proactively influence physical growth and change in a manner consistent with this vision. The General Plan provides the City with multi-disciplinary strategy for achieving the vision in the context of land use, circulation & mobility, housing, open space, conservation, public safety, noise, cultural resources & historic preservation, growth management, economic development, infrastructure and urban design elements.

The City of Redlands General Plan Land Use Element (adopted 2017) identifies a vision for future development and land uses in the Specific Plan Area. This Specific Plan is a land use tool to more specifically guide, control, and regulate future development in the Specific Plan area in a manner that implements the land use vision and the goals and policies identified in the General Plan. *Exhibit 1.5, Existing General Plan Designation*, shows the project site land use designation. *Exhibit 1.6, Proposed General Plan Designation*, shows the proposed change to the project site land use designation.

## 1.7 Project Objectives

---

The Heritage Specific Plan is designed to implement a series of objectives that have been carefully crafted to ensure that the Project results in a high-quality development, which meets realistic and achievable objectives. These objectives, which are identified below, have been refined throughout the planning and design process for the Project:

- **Quality Design.** Build upon the platform of high-quality design, architecture and landscaping established by the neighboring communities to provide a cohesive, pedestrian-friendly community that offers open space amenities.
- **Housing Stock.** Address the City’s current and projected housing needs for family-oriented single-family detached homes.
- **Compatibility.** Implement the City’s General Plan Land Use Element goal to provide a compatibility of land uses.
- **Mobility.** Create a system of roads, trails and sidewalks that will fulfill the policies of the Redlands General Plan by allowing residents to live in proximity to park and recreational opportunities.
- **Safety.** Provide a network of pleasant, safe, and convenient sidewalks connecting the project with the public realm.
- **Sustainability.** Incorporate “green” and sustainable practices, as practicable, in developing buildings and infrastructure.
- **Landscape.** Maximize opportunities for using water-wise plant materials in the project landscaping palette to promote water conservation.
- **Fiscal Responsibility.** Undertake development of the project site in a manner that is economically feasible and balanced to address both the Applicant’s and City’s economic concerns.

## Exhibit 1.2, Regional Location

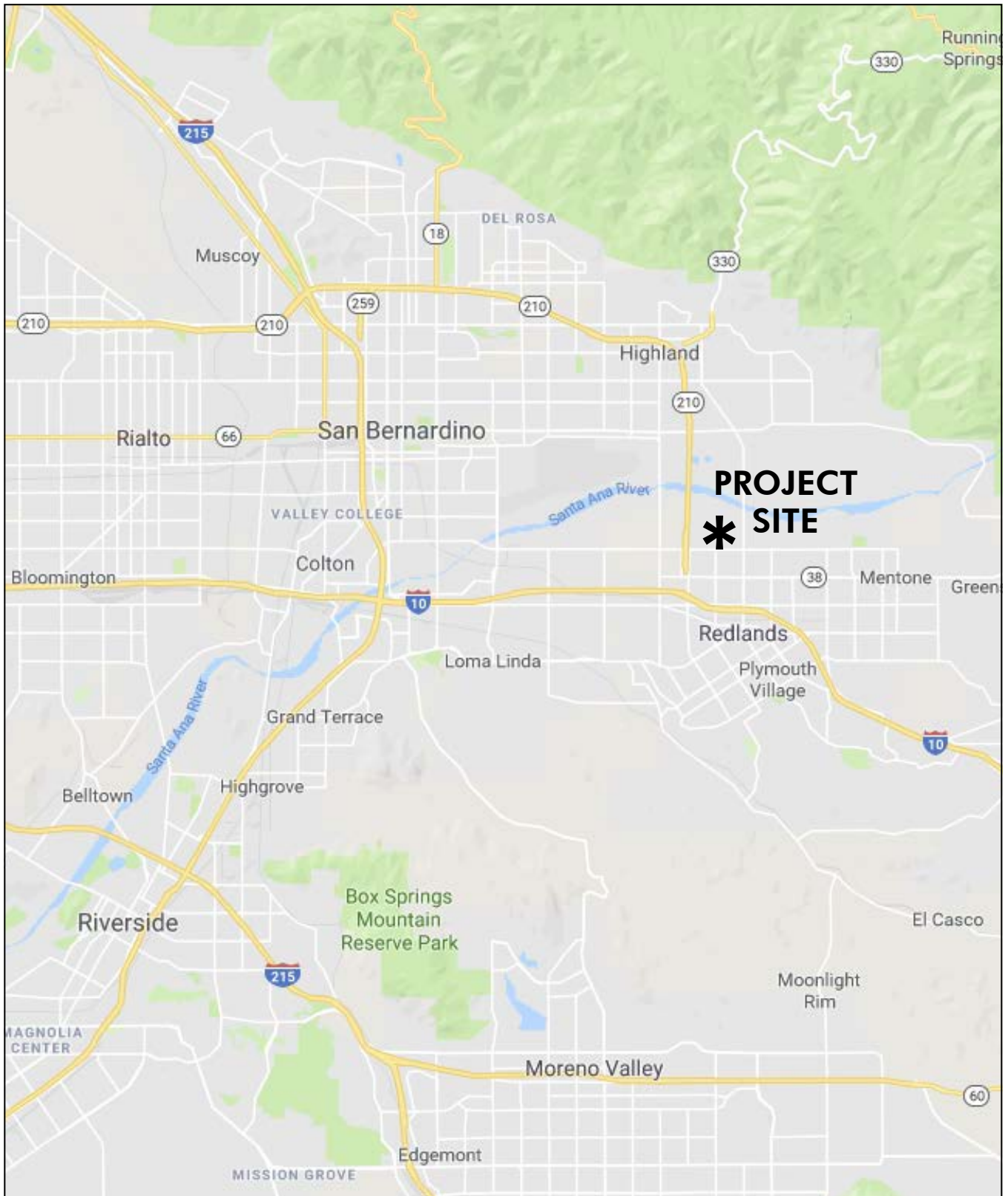

Source: Google Maps

⌚ N. T. S.

# Exhibit 1.3, Local Vicinity



Source: Google Earth

N. T. S.



# Exhibit 1.4, Specific Plan Area (APN's)

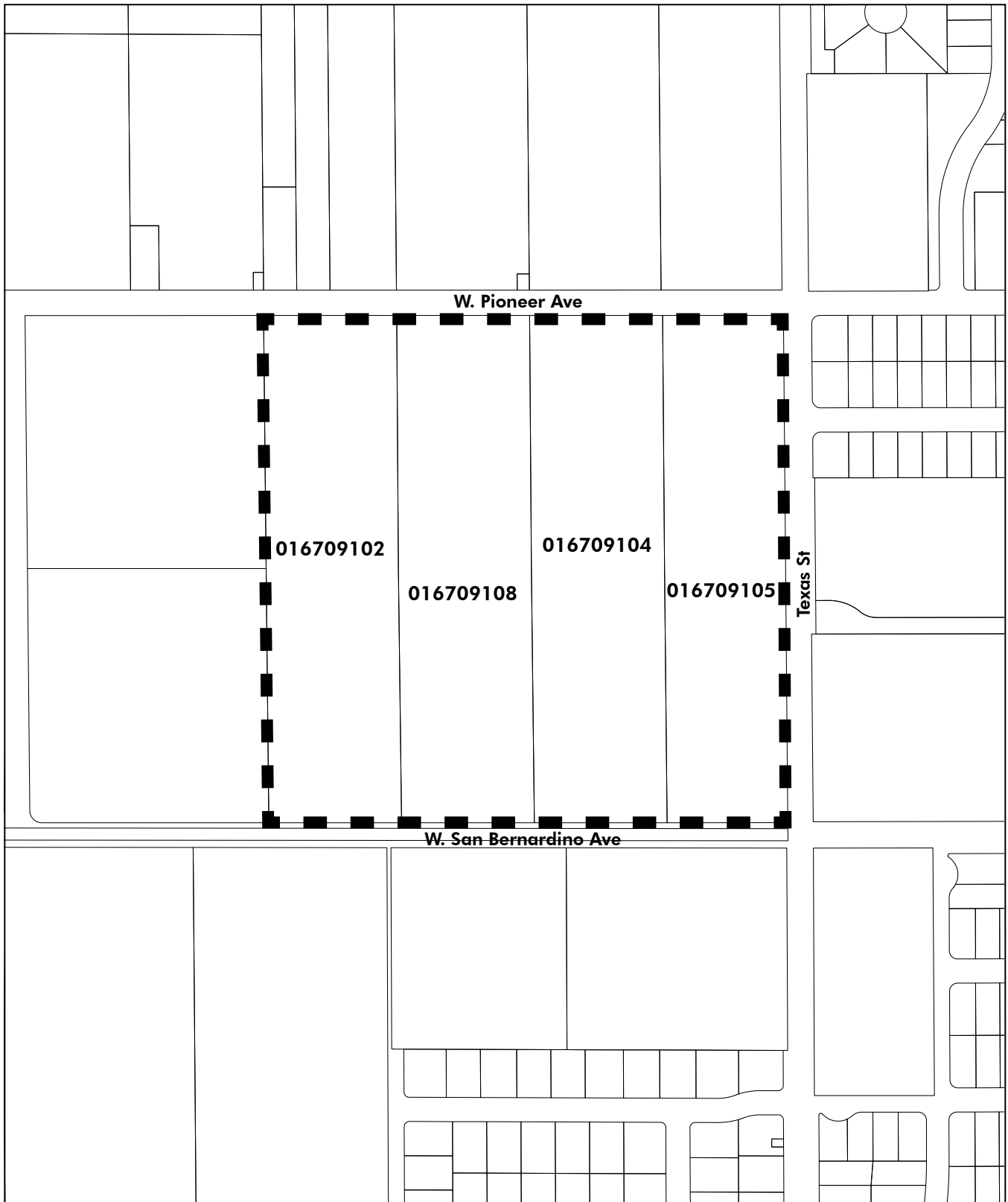

Source: San Bernardino County GIS

⌚ N. T. S.

# Exhibit 1.5, Existing General Plan Designation

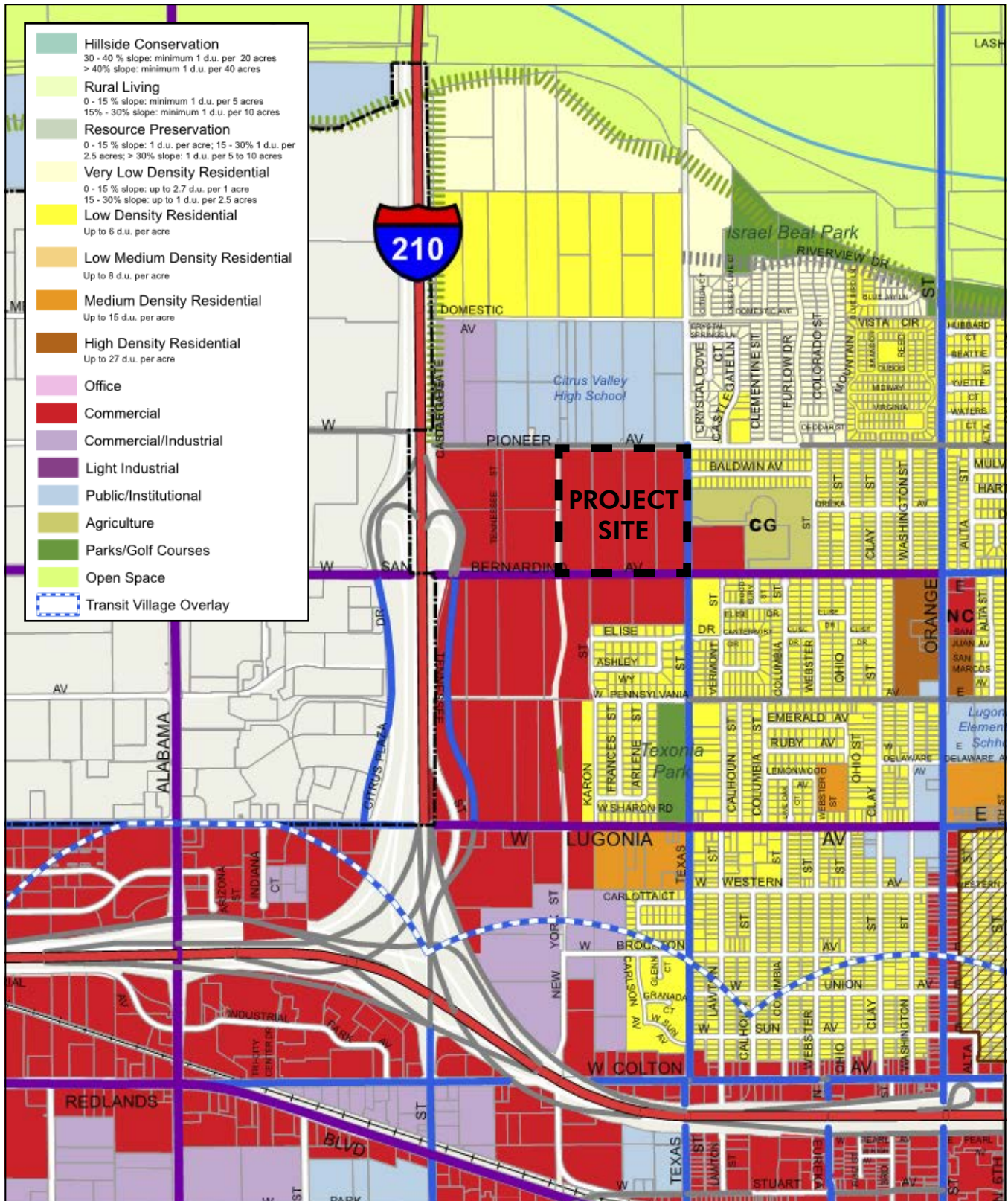

Source: Redlands General Plan 2035

N. T. S.

# Exhibit 1.6, Proposed General Plan Designation

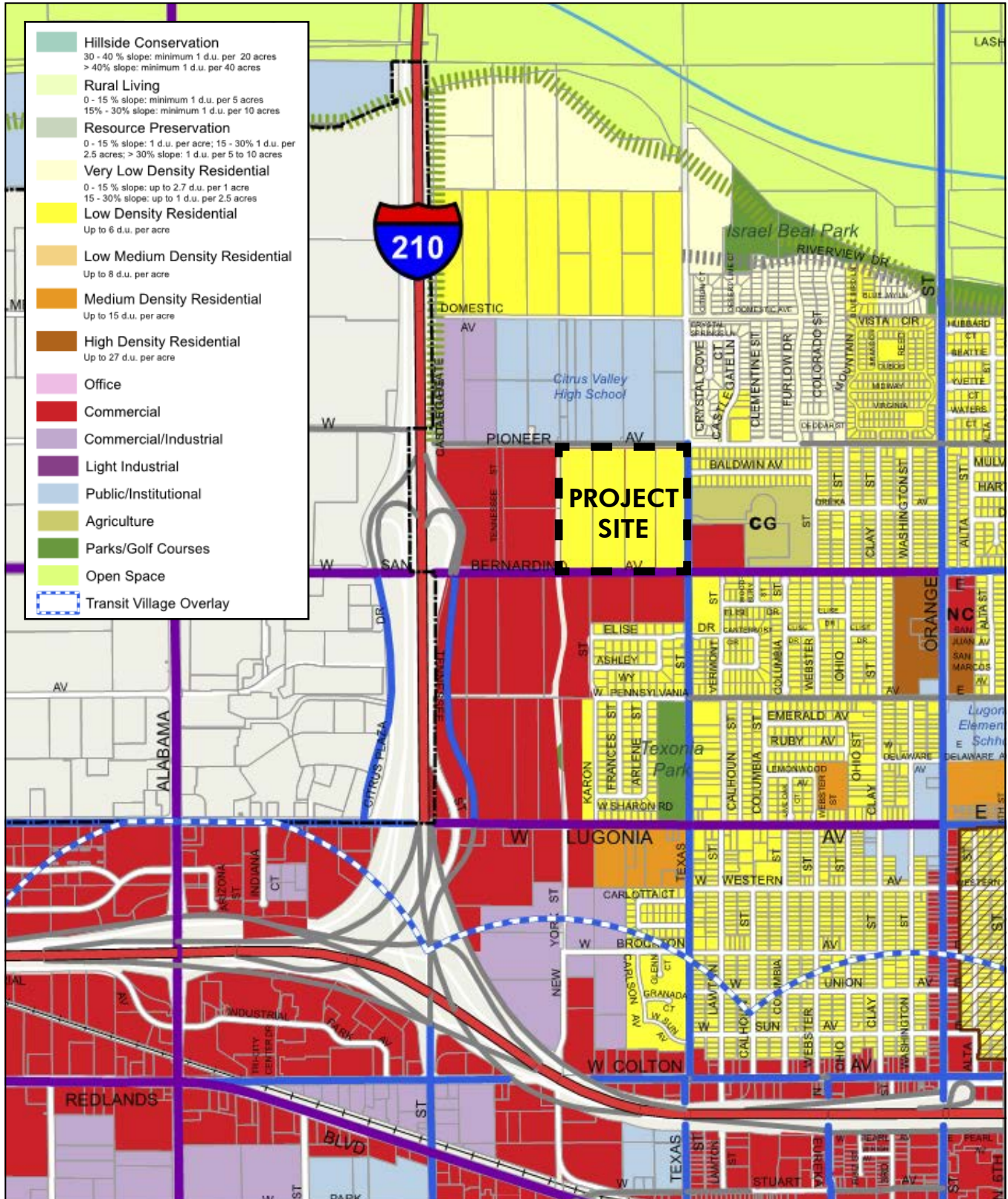

Source: Redlands General Plan 2035

N. T. S.

# Exhibit 1.7, Zoning Designation

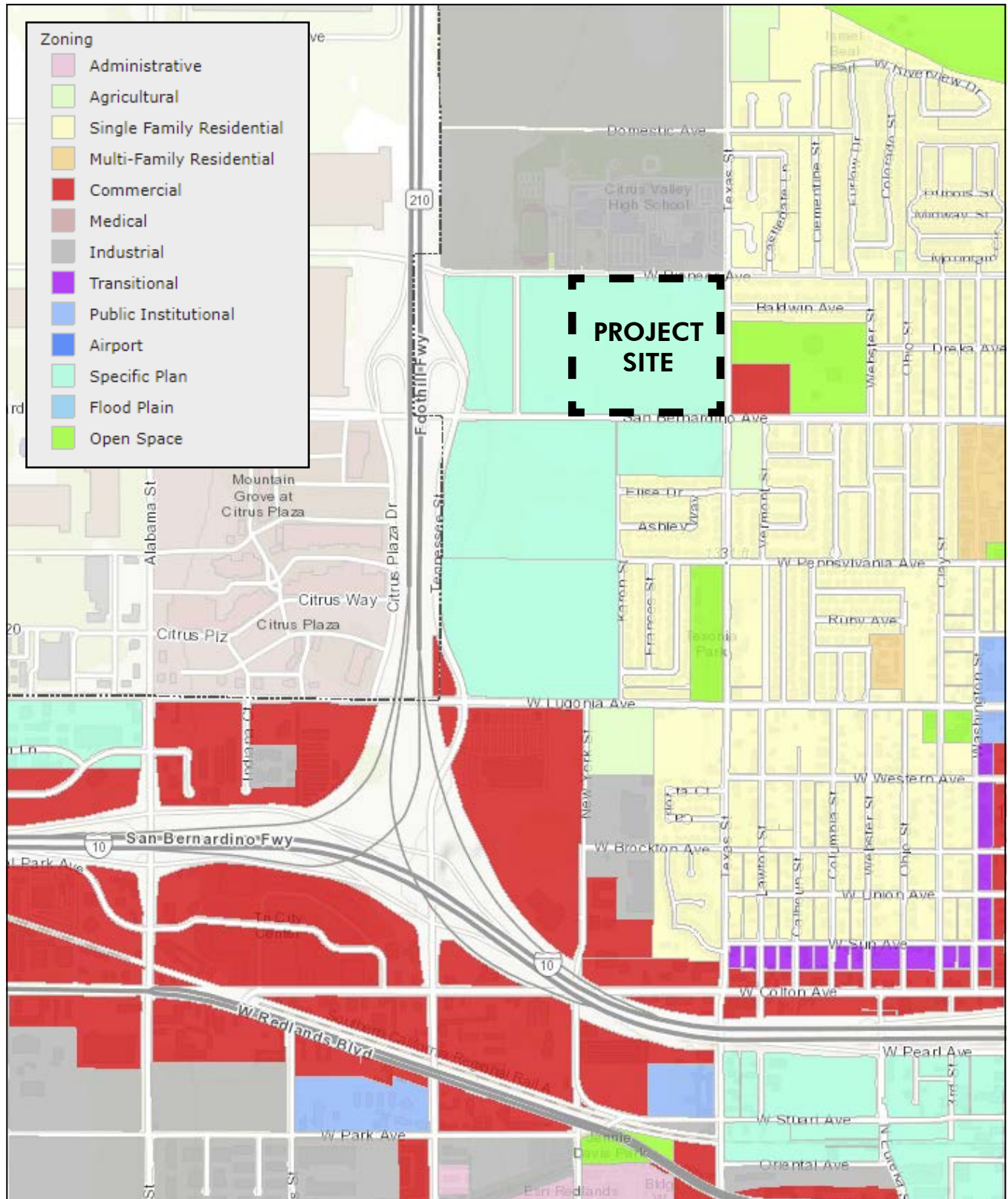

Source: City of Redlands Zoning Map

N. T. S.

# 2

## DEVELOPMENT REGULATIONS

### 2.1 Purpose and Intent

---

This chapter establishes the permitted uses and physical development standards and regulations for the planned development. The standards and regulations contained in this chapter shall supersede those of the Redlands Municipal Code, unless otherwise stated herein. Where the language in this Specific Plan is undefined, the final interpretation and determination shall be made by the City's Director of Development Services. In instances of conflicts, the regulations and standards contained in this Specific Plan shall take precedence over the Municipal Code. If this Specific Plan is silent, then the standards in the Redlands Municipal Code or other applicable city, state or federal code shall apply, as appropriate.

### 2.2 Permitted Uses

---

This section sets forth the uses permitted within the Specific Plan area. Other uses not specifically listed here may be permitted by the City's Director of Development Services if the proposed use is deemed to be consistent with the purpose and intent of the approved Heritage Specific Plan.

#### A.) Permitted Uses

- 1.) Single-family detached dwellings
  - a.) A maximum of one dwelling unit per lot
  - b.) Home occupations in accordance with Redlands Municipal Code
  - c.) Patio covers within the private patios

#### B.) Permitted Accessory Land Uses

- 1.) Accessory buildings (pools, cabana, or storage shed)
- 2.) Community recreational facilities for homeowners and guests

## 2.3 Development Standards

---

This section sets forth the development standards for buildings located in the Specific Plan area. The development standards included herein are intended to establish the minimum design parameters.

### A.) Parking

A minimum of two (2) enclosed garage spaces shall be provided per unit. Enclosures shall comply with all yard requirements. An additional two (2) driveway spaces shall be provided per unit.

### B.) Fences and Walls

Fences and walls shall be permitted within the front, side, and rear yard setback areas, except as provided below:

- 1.) Fences may not be erected within public street rights-of-way.
- 2.) No fence or wall shall exceed six (6) feet in height, unless a higher wall is specifically required for sound attenuation purposes. The height of the fence or wall shall be measured from the highest ground level immediately adjacent to the base of the wall.
- 3.) In instances where a side or rear yard fence or wall is located adjacent to a public right-of-way, then the maximum fence height shall be six (6) feet as measured on the public right-of-way side.
- 4.) Privacy walls, if provided in side and rear yards, shall be a minimum of five and one-half (5-1/2) feet in height.
- 5.) In front yard setback areas, solid fences and walls shall not exceed 36 inches in height. Pilasters and columns may be provided up to six (6) feet in height.
- 6.) All pool enclosure fencing shall conform to applicable State of California or City of Redlands pool code fencing requirements, whichever is more stringent.
- 7.) Side yard retaining walls conforming to City Standards may be used within the project.

### C.) Signage

Signage within the Specific Plan shall be permitted as per the provisions of the Redlands Sign Code.

### D.) Slope Grading

Slope grading shall be designed so that there are no slopes over 2:1 in the subdivision.

**Table 2.1, Development Standards**

Residential Development Standards	
<b>Density</b>	
Maximum dwelling units per net acre	6 du/ac
<b>Lot Area</b>	
Minimum lot area per dwelling unit	2,800 sf.
<b>Lot Coverage</b>	
Maximum coverage	55%
<b>Lot Dimensions</b>	
Minimum lot width	40'
Minimum lot depth	65'
<b>Building Height</b>	
Maximum height of any structure	2 stories, 32' ft.
<b>Setbacks<sup>1</sup></b>	
Minimum front yard	10'
Minimum rear yard	10'
Minimum corner side yard	10'
Minimum interior side yard	5'
Minimum to garage	18'

NOTES:

1) Architectural projections may encroach into setback a maximum 30 inches. Projections include architectural ornamentation including outlookers, corbels, roof overhangs, chimneys, non-structural pop-outs, plant shelves, pot shelves, shutters, etc. A minimum clearance of 48 inches at the ground floor level to be provided.

## Exhibit 2.1, Conceptual Lot Layout

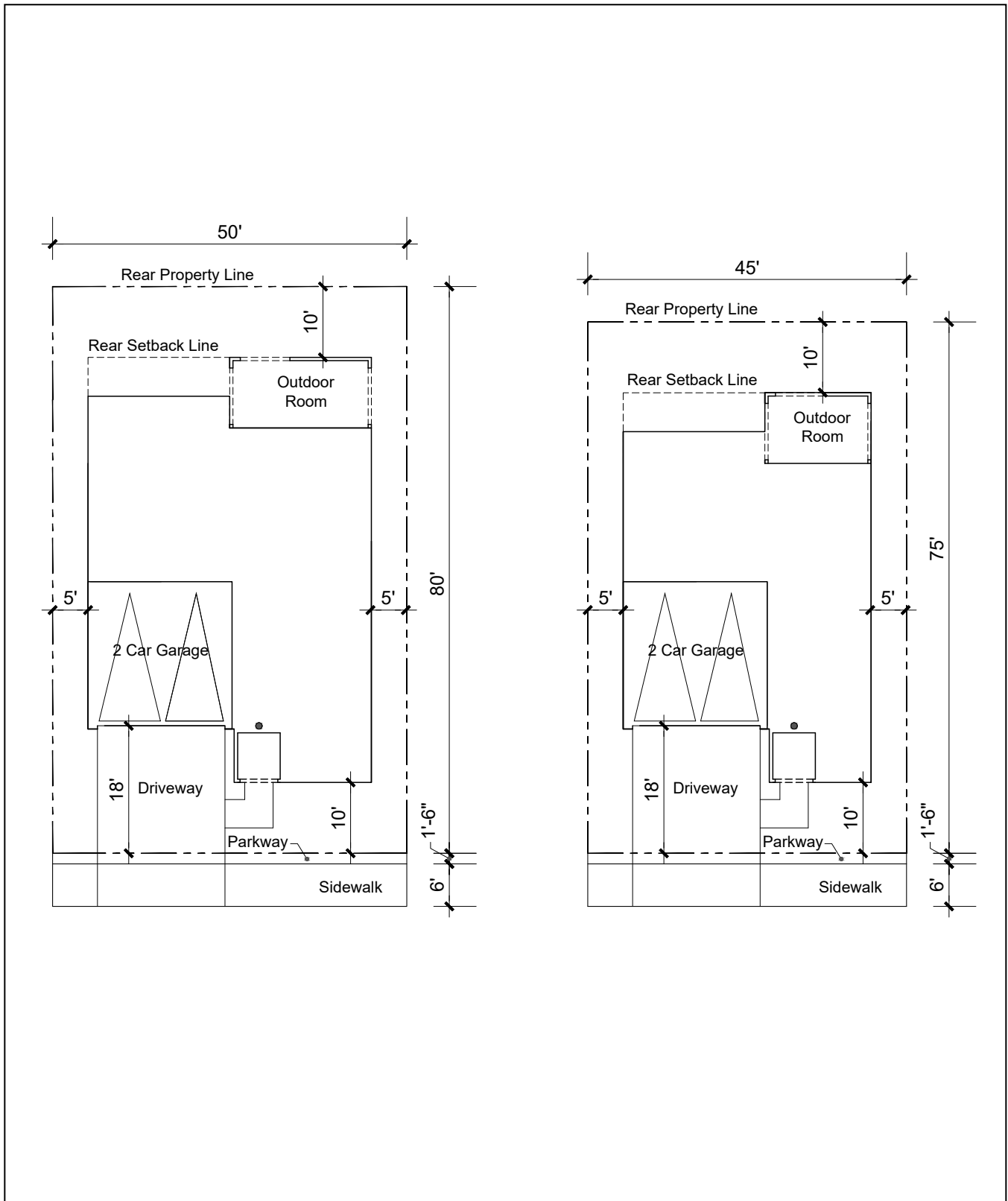

Source: KTG Group, Inc.

N. T. S.



# 3

## DESIGN GUIDELINES

### 3.1 Purpose and Intent

---

This chapter contains landscaping, site planning and architectural design guidelines for the Heritage Specific Plan area. These guidelines, when implemented, will ensure the project develops as a high-quality master planned community with consistent design elements. The design guidelines provide a general direction to planners, builders, architects, landscape architects and engineers who will be involved in the development of the community.

The essence of good design is creativity and flexibility. The design guidelines are intended to foster these ideals and promote innovation, and should not be construed to be rigid standards that cannot be modified. The graphic representations contained herein are provided for conceptual illustration purposes only, and are to be used as general visual aids in understanding the basic intent of the guidelines. They are not meant to depict actual neighborhood, lot or building design.

To encourage creativity and innovation, the design guidelines express “intent’ rather than “absolutes,” thus allowing a certain degree of flexibility in fulfilling the intended design goals and objectives.

### 3.2 Neighborhood Design Components

---

The neighborhood of Heritage will be designed to reflect the character, charm and diversity reminiscent of traditional American pre-war towns. The traditional neighborhood character will be achieved by incorporating the following:

- » Street and trail systems that provide connectivity among recreational amenities, open space areas and surrounding communities.
- » Streetscape designs that encourage pedestrian use, provide comfort and enhance safety.
- » Open space elements of varying sizes, activity levels and characters as recreation and gathering spaces for residents.
- » Diversity in housing product types to appeal to people of different age groups and socio-economic backgrounds.
- » Architectural styles that reflect the architectural heritage of Redlands and are reminiscent of a small town atmosphere where neighborhoods evolve over time.

### 3.3 Architectural Guidelines

---

The purpose of the architectural guidelines is to identify the general architectural design criteria for buildings in Heritage. The design guidelines presented herein are intended to establish the overall architectural character for the community and reflect the historical development precedents of Redlands. The goal is to promote both visual compatibility and variety in a small town setting by utilizing a number of compatible styles and through quality architectural innovation. This ensures that Heritage will be developed in a manner that will blend with and enhance the existing character of the City.

#### A.) Architectural Character

The design intent is to create a collection of intimate neighborhoods that will blend gracefully into the existing residential communities of Redlands. To achieve this, two architectural styles have been identified as appropriate for use in Heritage. In addition, building design should focus on human-scale details that enhance the pedestrian friendly character of the neighborhoods, such as front porches, enhanced entries, a mix of materials and textures, and authentic detailing on features. Together, these design features enliven the streetscene and promote the friendly interaction of neighbors.

The architectural styles planned for Heritage include, but are not limited to, the following:

- » Craftsman
- » Spanish Eclectic
- » Ranch

A description of each architectural style and key design features are included in this section. The descriptions and illustrations are intended to serve as design inspiration for the development of architecture in Heritage, and are not indicative of the actual product types in individual projects. This Specific Plan allows flexibility to create variety in architectural expressions and interpretation of the design styles, while also establishing the framework to achieve harmony and compatibility throughout the neighborhoods.

#### B.) Architectural Design Criteria

Heritage is envisioned to be a walkable neighborhood that is organized around intimate open space, parks and recreational amenities. The neighborhood will have a central green/mini park that functions as a gathering place, and connective trails and pathways that link the neighborhood with the surrounding community. Authentic architecture that responds to the local setting and history is strongly encouraged.

The general design guidelines for residential development are as follows:

##### ***Building Siting and Orientation***

1. Orient the front of the buildings toward the streets and open space, wherever feasible.
2. Buildings with increased public visibility should respond by wrapping architectural detailing and elements around the corners and on rear elevations that face a street.

# Craftsman

## Historical Precedent

The Craftsman style grew out of Bungalow architecture and was strongly influenced by the English Arts and Crafts movement. It is an American style that originated in Southern California, and spread across the country during the 1920s and 1930s through pattern books and catalogues.

The Craftsman style sought the elimination of superfluous ornamentation, creating beauty instead through the simplified lines and masses of the building itself. This unique style promoted hand crafted quality to create natural, warm and livable homes.

## Design Characteristics

- » Full- or partial-width porches with horizontal railings pickets
- » Low- to moderate-pitch gable roofs with broad or deep overhangs with exposed rafter tails at the eaves and trellises over the porches
- » Knee braces
- » Detailed porch columns
- » Windows typically grouped in sets of two or three
- » Shed or gable dormers
- » Stucco, stone, brick, shingles and horizontal siding

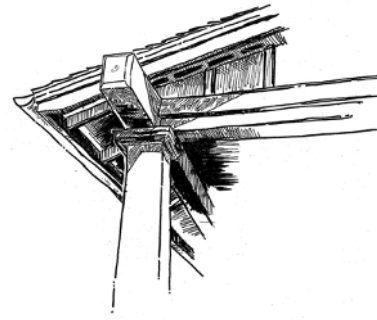

**Overhangs**

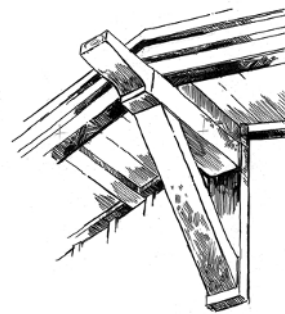

**Outlookers**



**Battered Columns**

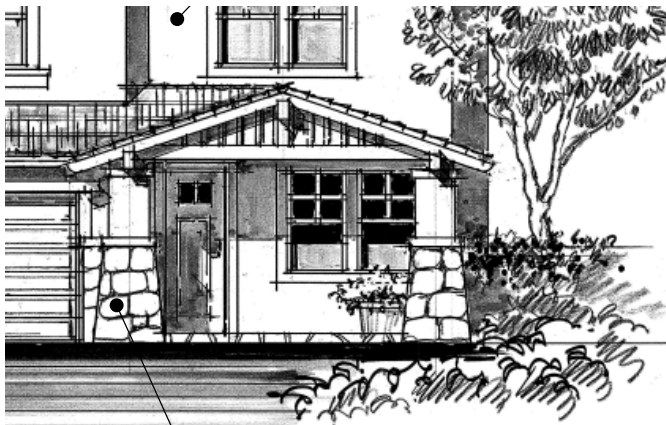

Stucco Columns w/ Battered Stone base

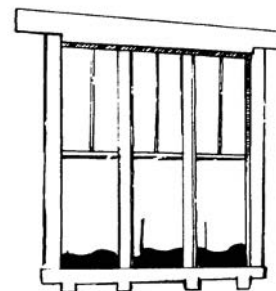

**Ribbon Windows**

## Spanish Eclectic

### **Historical Precedent**

The Spanish Eclectic style was popular during the 1920s and early 1930s. Also known as Spanish Colonial, this style incorporated the details and ideals of Spanish architecture, which took its cues from the missions of the early Spanish missionaries and included details from the Moorish, Byzantine, Gothic and Renaissance architectural styles. California, Arizona, Texas and Florida are all regions where Spanish Eclectic house plans and architecture are common. The charm of this style lies in the directness, adaptability and contrast of materials and textures.

### **Design Characteristics**

- » Low-pitched roof
- » Red roof tiles
- » Stucco walls
- » Round or square exterior columns
- » Arches, especially above doors, porch entries and main windows
- » Decorative tiles around doorways and windows
- » Windows with decorative grillwork

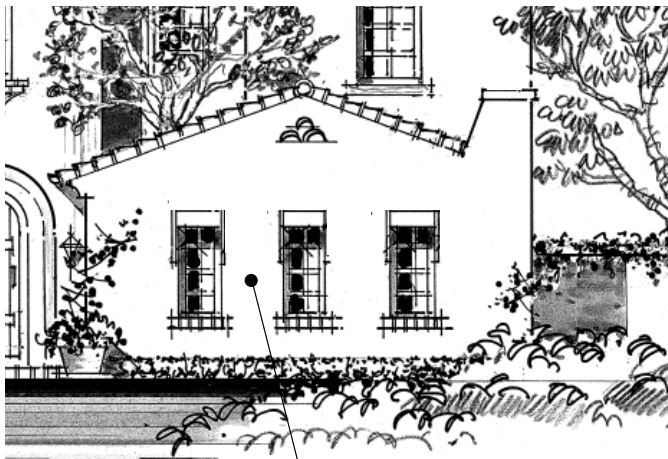

Exterior Material: Stucco

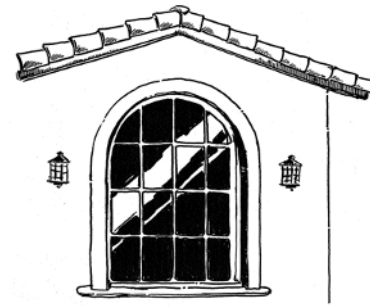

**Arch-Top Featured Window**

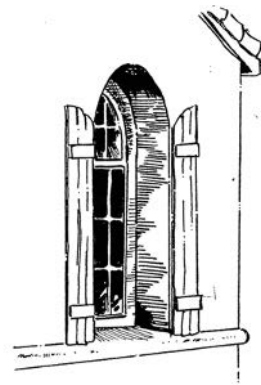

**Plank Shutters**

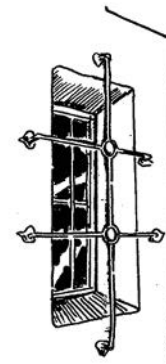

**Wrought Iron**

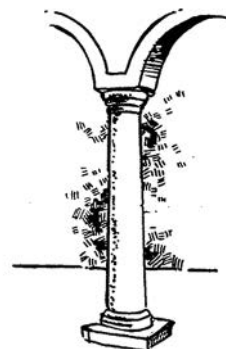

**Columns**

# Ranch

## Historical Precedent

The Ranch style is an American domestic architectural style. First built in the 1930s in California, the Ranch style became extremely popular in the United States after World War II. The earliest Ranch style homes reflect a relaxed, casual Western lifestyle.

The typical Ranch home has a gable roof and is noted for its minimal use of exterior and interior decoration. Although Ranch style homes are traditionally one-story, Raised Ranch and Split-Level Ranch homes have several levels of living space. Contemporary Ranch style homes are often accented with details borrowed from Mediterranean or Colonial styles.

## Design Characteristics

- » Spreading, horizontal orientation; low to the ground
- » Low hipped or gabled roof, often with wide eaves
- » Minimal ornamentation
- » Incorporation of natural materials
- » Design elements such as sliding glass doors and large plate glass picture windows
- » Simple, open floor plans

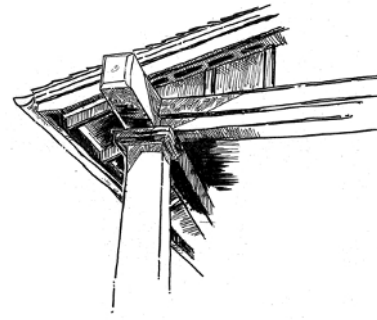

**Deep Eaves**

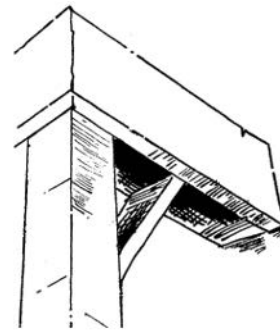

**Sqare Post with Simple Brackets**



**Porch**

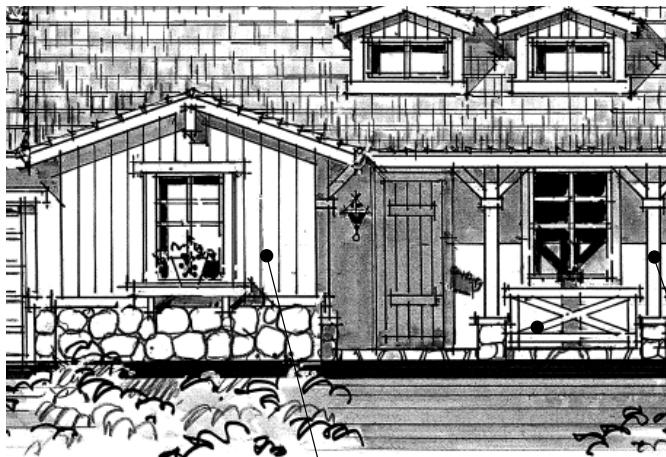

— Exterior Materials:  
Stucco, w/ Limited Wood Siding as Accent  
w/ Stucco or Stone Base

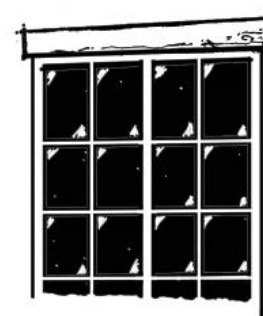

**Wood Window Header**

### ***Building Form, Scale and Massing***

1. Form and massing should be established by the characteristics of the building's architectural style.
2. Building forms should be of simple geometry.
3. Encourage reduced massing along open space and pedestrian-oriented edges to enhance views and/or create a pedestrian-friendly environment.
4. Variation in scale, massing and details should be incorporated among nearby buildings.

### ***Building Façades, Features and Details***

1. All design features and details should complement the architectural style of the building.
2. All design elements should appear as an integrated part of an overall site design concept. Details should be integrated into the buildings and not simply applied as an afterthought.
3. Buildings facing the streets, walkways and open space areas should incorporate architectural features such as windows, shutters, etc., that provide human scale and add visual interest to the façades.
4. Front entries should be clearly visible and directly accessible from the street, where appropriate.
5. Architectural massing and articulation, landscaping and/or lighting should be used to highlight the location of the front entrances.
6. Porches and stoops may be used to highlight the front entries and provide a transition from the public street to the private dwelling.
7. Windows and doors should be detailed, sized and positioned appropriately in the context of the architectural style.
8. Windows on side elevations should be staggered, where possible, so as not to be positioned directly opposite the windows on the adjacent buildings.
9. Homes on corner lots should be designed for two-sided corner exposure with enhanced architectural elements.

### ***Building Materials and Colors***

1. Building materials should be compatible with the architectural style of the home. Permitted building materials include, but are not limited to, stucco, brick, stone, and wood-like siding/shingle.
2. Building materials should be high quality, durable and low maintenance.

3. Building color palettes should be authentic to the selected architectural styles of the homes.
4. Primary building colors should be neutral and muted in hue. Brighter and more saturated colors should be used as accent colors only or as part of a balanced, carefully executed color scheme.

#### **Roofs**

1. Roof forms and materials should reflect the selected architectural style of the building.
2. Roofs should be designed to appear harmoniously with one another in terms of form and color.

#### **Garages**

1. Where a garage faces the street, it should be recessed from the building façade and be de-emphasized through placement form, color and materials.
2. Garage doors should be set into, rather than flush with, the exterior building walls.

### **3.4 Landscape Guidelines**

---

Landscape plays a significant role in the creation of a new community. Streetscape, parks, open space and scenic natural features in the Specific Plan area are place making opportunities that will collectively establish an identity for Heritage. The goals of the landscape guidelines are to create a distinctive image for the community, reflect the setting and character of Redlands, reinforce the small town feel, and respond to the unique natural features of the land.

A rich variety of plant species with appropriate color, texture and size and appropriate hardscape materials should be used throughout to convey the overall character of the community, as well as blend with the surrounding natural and man-made landscape. To promote sustainability, drought-tolerant or water-wise plant materials with proven adaptation to the local climate.

The following principles will guide the landscape design of Heritage:

- Establish a unique identity and sense of place.
- Visually tie the neighborhood together with the surrounding community.
- Create pedestrian-friendly streetscape.
- Incorporate plant materials and landscape features that promote long-term sustainability.

#### **A.) Landscape Master Plan**

A distinctive and cohesive landscape design concept will create a strong sense of place for the community and enhance social and recreational opportunities for the residents. *Exhibit 3.1, Conceptual Landscape*

*Master Plan*, depicts the proposed locations of key landscape features in Heritage, including the community entries, landscape corridors, paseos, parks and development edge buffers.

## **B.) General Landscape Design Criteria**

In both public and private spaces, landscape should be designed with an understanding of massing, scale and view opportunities. The following design criteria should be taken into consideration:

1. Landscaping should define edges, soften building contours, highlight important architectural features, provide shade for pedestrians, add visual interest, and screen less attractive elements.
2. Incorporate special landscape treatments at entry areas and special nodes such as building entries, street intersections and public gathering areas.
3. Where appropriate, use special landscape elements such as arbors, trellis, and benches to create focal points, enhance visual interest and provide pedestrian comfort. Landscape elements should relate to the character and scale of the neighborhood and the surrounding space.
4. Plant material selections and locations should consider the site, soil conditions, solar orientations and relationships to adjacent streets and buildings.
5. Wherever possible, select plant materials that require minimal irrigation following establishment, do not require active maintenance such as mowing or use of chemical fertilizers, pesticides or herbicides.
6. Combine plant materials of different colors and textures to create visual interest.
7. Development perimeter edges should be buffered by using planting materials that blend harmoniously with the surrounding landscape.
8. Flowering plants are encouraged in parks to create colorful, animated gardens.
9. Street trees may be either informally or formally spaced, but should average not less than 30' on center spacing where the site plan can accommodate such spacing. Planting of street trees should be coordinated with public utility easements and above-ground structures as necessary.
10. Specimen trees should be used at community and neighborhood entries, parks and key planting medians to provide focal points.
11. Paseos/trails and residential streets should offer canopy trees and flowering accent trees to provide shade and color.
12. Landscape plans for any development should consider traffic safety sight line requirements and structures on adjacent properties to avoid conflicts as the trees and shrubs mature.



# Exhibit 3.1, Conceptual Landscape Master Plan



Source: RHA Landscape Architects



13. Street trees and trees in private landscaped areas near public walkways and street curbs should be selected and installed to prevent damage to sidewalks, curbs, gutters and other public improvements as much as possible.
14. Automatic irrigation systems should be installed in rights-of-way, and public areas. In areas where irrigation is required, the irrigation system should be designed to maximize efficiency and limit or eliminate the use of potable water. Potential strategies for reducing irrigation water include using low water use plantings, high-efficiency equipment including, but not limited to, drip irrigation, and use of recycled wastewater where feasible. Irrigation design should utilize weather- and climate-smart controllers, irrigation zones to suit plant requirements, and high-efficiency nozzles.
15. Erosion control techniques to mitigate increased runoff should be integrated with the overall landscape design. Emphasis should be placed on drainage solutions that conform to the natural character of the landscape.
16. Street tree species need to be approved by Facilities and Community Services Department with input from Southern California Edison when next to above ground utility wires.

### **C.) Plant Palette**

It is the intent of these guidelines to provide flexibility and diversity in plant material selection, while maintaining a cohesive plant palette in order to establish greater unity and thematic identity in the Heritage community. The plant materials listed in this section have been selected for their appropriateness to the project theme, climatic conditions, soil conditions, water requirements and ongoing maintenance.

Plant material selections shall be reviewed and approved by the City during the review of the proposals for individual projects. Additional plant materials not listed below may be allowed by the City on a case-by-case basis during review of neighborhood project proposals.

The recommended plant palette is organized into the following three categories according to the area of use:

- » Community streetscape
- » Natural/naturalized areas, development edge buffer, landscape corridors, parks, paseos, entries, residential and mixed use areas
- » Parks, paseos, entries, residential and mixed use area only (for use in more manicured planting areas)

**Table 3.1, Plant Palette**

Use	Botanical Name	Common Name
<b>Street Trees</b>	<i>Koelreuteria paniculata</i>	Golden Rain Tree
	<i>Platanus acerifolia</i>	London Plane Tree
	<i>Podocarpus gracilior</i>	Fern Pine
	<i>Quercus ilex</i>	Holly Oak
	<i>Ulmus parvifolia</i>	Evergreen Elm
	<i>Arbutus x 'Marina'</i>	Arbutus Standard
	<i>Handroanthus impetiginosus</i>	Pink Trumpet Tree
<b>Perimeter Trees</b>	<i>Olea europaea</i>	Olive Multi-Trunk
	<i>Pistacia chinensis</i>	Chinese Pistache
	<i>Tristania conferta</i>	Brisbane Box
<b>Park Trees</b>	<i>Pinus eldarica</i>	Afghan Pine
	<i>Platanus racemosa</i>	California Sycamore Multi-Trunk
	<i>Ginkgo biloba</i>	Ginkgo Tree
	<i>Jacaranda mimosifolia</i>	Jacaranda Mimosifolia
	<i>Cercis canadensis 'Forest Pansy'</i>	Forest Pansy Redbud
	<i>Lagerstroemia indica 'Red Rocket'</i>	Red Rocket Crape Myrtle
<b>Shrubs</b>	<i>Aloe striata</i>	Coral Aloe
	<i>Anigozanthos x 'Big Red'</i>	Red Kangaroo Paw
	<i>Senna artemisioides</i>	Feathery Cassia
	<i>Dasyllirion wheeleri</i>	Desert Spoon
	<i>Dianella revoluta 'Baby Bliss'</i>	Baby Bliss Lily Flax
	<i>Echium candicans</i>	Pride of Madeira
	<i>Festuca mairei</i>	Atlas Fescue
	<i>Rhus ovata</i>	Sugar Bush
	<i>Russelia equisetiformis</i>	Firecracker lant
	<i>Senecio mandraliscae</i>	Blue Chalk Sticks
	<i>Myoporum parvifolium 'Pink'</i>	Pink Australian Racer

## 3.5 Open Space Guidelines

---

The open space component of the Heritage community includes parks, landscape corridors adjacent to major streets, development edge buffers, and paseos. These areas are designated as open space to provide recreation areas, pedestrian/bicycle travel, flood control through the use of enhanced drainageways, and buffer zones.

A collection of open space elements of different types and sizes will be provided, offering an array of active and passive recreational amenities, and support facilities for public enjoyment. A centrally located park will be connected via pedestrian paseos that traverse the community. Precise park locations will be determined at the time of the subsequent Tentative Map submittals. The ultimate design and layout of park amenities are subject to change pending final design and approval by the City.

A series of nodes, ranging in size, will be located within Heritage. These smaller areas generally provide open space intended to serve as connection points to the public right-of-way. Typical amenities at these nodes may include picnic tables/seating, gardens, and walking/bike paths.

### **General Open Space Development Guidelines**

The following guidelines apply to parks within Heritage:

1. Parks should contain recreation amenities and facilities consistent with the needs of nearby residents.
2. Park landscaping should incorporate low water use plant species, wherever possible, to reduce irrigation and maintenance needs.
3. Parks should be linked to the surrounding land uses via trails and/or sidewalks.
4. Park amenities should be designed and constructed for maximum durability and safety and minimal maintenance.
5. Parks should be designed to facilitate surveillance by police, security services and nearby residents.
6. Park development should occur in conjunction with the adjacent residential development.

## 3.6 Entry Treatments

---

Neighborhood entries should consist of a thematic blend of special landscape treatments, monumentation, specialty lighting and/or architectural features. These entries will serve as area landmarks, while reinforcing the distinctiveness of Heritage. Project entry monument will be designed by the developer(s)/builder(s) and submitted to the City for review and approval.

It is the intent of the Specific Plan to allow flexibility in the design of the residential neighborhood entries to create interest and promote diversity. At the discretion of the developer/builder, each residential neighborhood entry may contain signage. Where provided, the signage should identify the name of the development within the planning area. The locations of the residential neighborhood entries will be determined at the time of the Tentative Map submittal for the planning areas.

# Exhibit 3.2, Conceptual Entry Treatments



COBBLESTONE  
TAPERED PILASTER

SLUMP BLOCK WALL  
WITH SACK FINISH

CRAFTSMAN STYLE  
ARBOR WITH  
COBBLESTONE  
PILASTERS

MONUMENT SIGN  
WITH COBBLESTONE  
VENEER AND  
TAPERED PILASTERS

ENTRY TREATMENT - VIEW FROM SAN BERNARDINO AVE



CRAFTSMAN STYLE  
ARBOR WITH  
COBBLESTONE  
PILASTERS

MONUMENT SIGN WITH  
COBBLESTONE  
VENEER AND  
TAPERED PILASTERS

SEAT WALL &  
PILASTERS WITH  
COBBLESTONE  
VENEER

CRAFTSMAN STYLE  
TRELLIS WITH  
COBBLESTONE  
PILASTERS

ENTRY TREATMENT - VIEW FROM TEXAS STREET

Source: RHA Landscape Architects



## 3.7 Community Walls & Fences

---

A cohesive wall and fence program is important to the overall appearance of the Heritage community. Walls and fences will be used to define the limits of property ownership, maintain privacy, attenuate sounds, provide for views and promote safety. Within Heritage, walls should not be a major visual element, and should be minimized wherever possible. Community wall and fence locations along major streets and open space/recreation areas may vary subject to final site design by individual developers/builders and noise mitigation requirements.

### **General Walls & Fences Guidelines**

The following guidelines apply to walls & fences within Heritage:

1. Where walls and fences face public streets and view corridors, they should appear thematically consistent in style, material and height.
2. Permitted types of walls and fences include, but are not limited to, slump block walls, split-face block walls, manufactured stone and stone walls, brick and simulated brick walls, wrought iron or tubular steel fencing, decorative metal, half block wall/glass or equivalent, vinyl fencing, wood fencing, and other types of materials acceptable to the City.

# Exhibit 3.3, Conceptual Community Wall Design

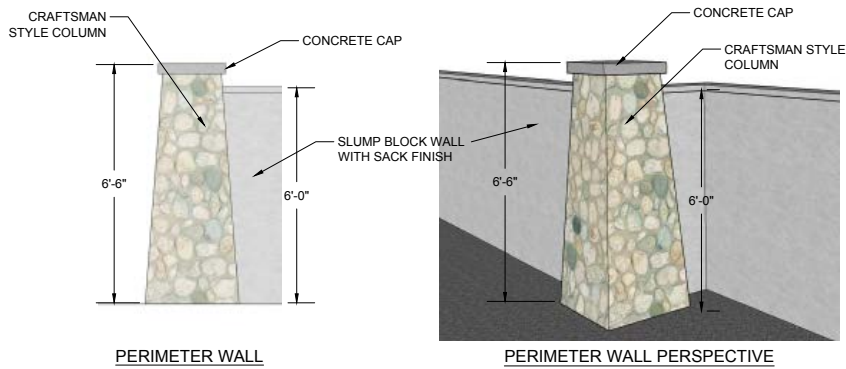

SACK FINISH WALL EXAMPLE

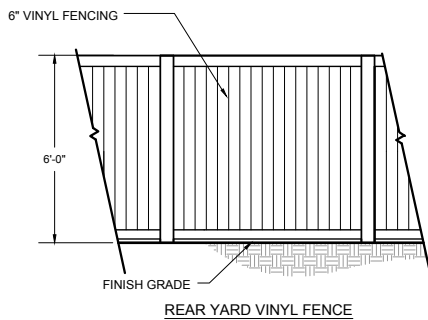

VINYL FENCE EXAMPLE

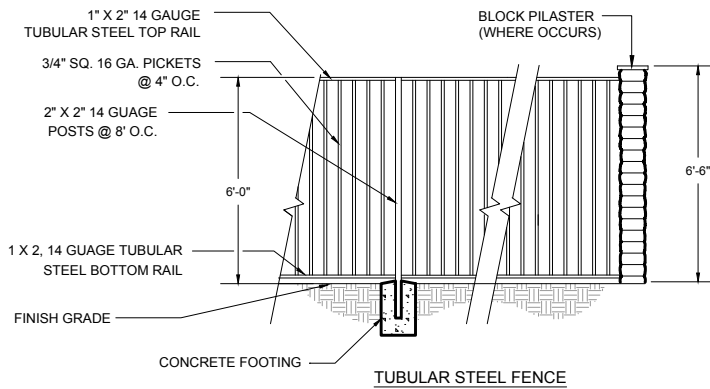

TUBULAR STEEL FENCE EXAMPLE

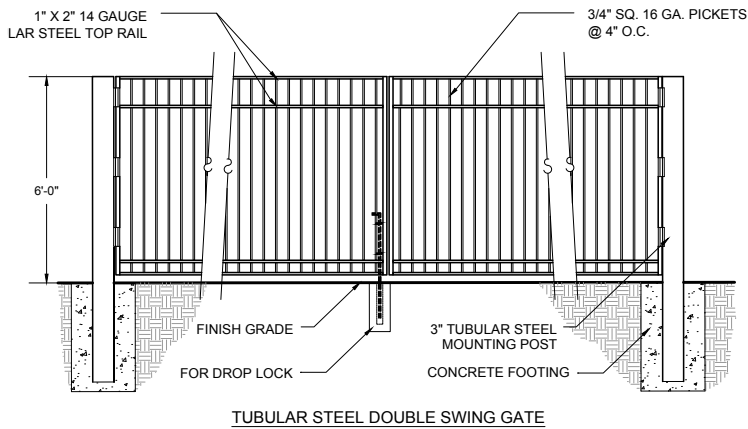

Source: RHA Landscape Architects





# 4

## INFRASTRUCTURE

### 4.1 Purpose and Intent

---

This chapter sets forth the plan for circulation and infrastructure improvements for the Heritage Specific Plan by describing each major infrastructure system. This chapter presents a conceptual layout of all infrastructure facilities within the specific plan area. The components of this chapter specifically defines design parameters and sets forth standards that will apply to land use entitlements and applications within the Heritage Specific Plan area.

### 4.2 Circulation

---

The circulation plan depicts the overall concept of traffic movement for the Heritage site. The vehicular circulation concept proposes to utilize the existing perimeter street network to service the land uses within the Project. These streets include Pioneer Avenue, Texas Street, San Bernardino Avenue, and the future New York Street. The Project site is also located close to two major freeways: I-10 and I-210. The classification of these streets within the City's General Plan include collector for Pioneer Avenue, future New York Street, minor arterial for Texas Street, and major arterial for San Bernardino Avenue.

The circulation plan is depicted in *Exhibit 4.1, Circulation Master Plan*. The internal street system within the residential portion of the Project has been designed to adequately serve the proposed residences within the development. Project-related roadway improvements will be completed consistent with the street standards presented in this specific plan and the General Plan. Specifically, improvements to San Bernardino Avenue, Texas Street, Pioneer Avenue and the future creation of New York Street and are described below.

#### A.) Pioneer Avenue

Pioneer Avenue, bordering the project to the north, has been designated as a collector street in the General Plan. Collector streets have a modified design standard of sixty-six (66) foot right-of-way width, with forty (44) foot curb-to-curb separation and five (5) foot wide sidewalks per the City's current Public Works Department standard street widths. The modified design standard provides an additional four (4) feet of street width and has a two (2) foot wider right-of-way width than the City's standard residential collector street section. To meet this standard additional right of way dedication and street improvements will be required along the property frontage on the south side of the street. No vehicular access to the project is proposed along Pioneer Avenue except for a restricted emergency vehicle access location at the northwest corner of the site. The north side of Pioneer Avenue was constructed to its ultimate width with the development of Citrus Valley High School and includes a painted left turn lane along the center of

# Exhibit 4.1, Circulation Master Plan

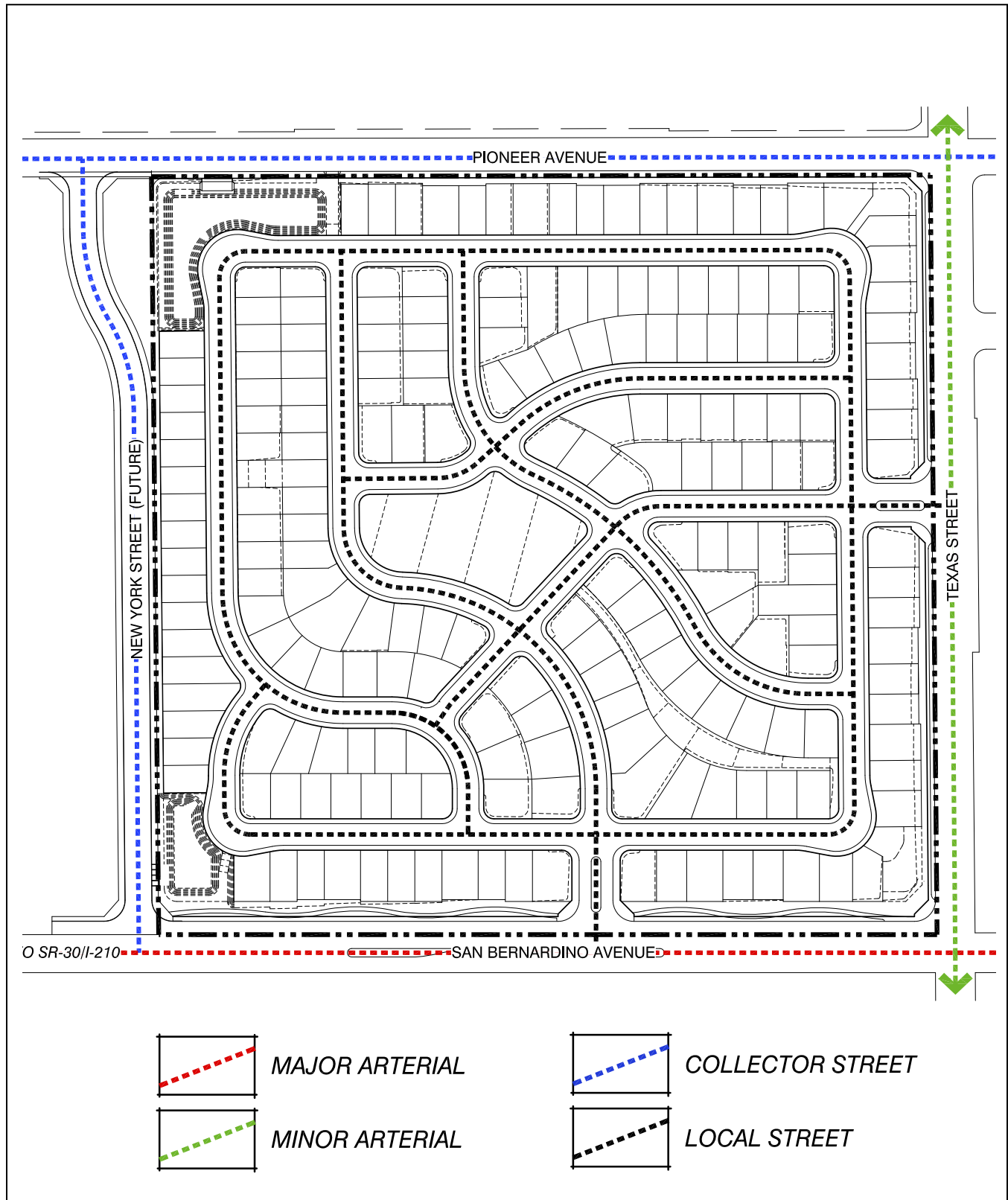

Source: Very Civil



the street. These improvements will not be modified with the proposed widening of the south side of the street.

## **B.) Texas Street**

Texas Street, bordering the project to the east, has been designated as a minor arterial in the General Plan. Four (4) lane undivided minor arterials have a design standard of eighty-eight (88) foot right-of-way width, with sixty-four (64) foot curb-to-curb separation and five (5) foot wide sidewalks per the City's current Municipal Utilities and Engineering Department standard street widths. To meet this standard, additional right of way dedication and street improvements will be required along the property frontage on the west side of the street. Vehicular access to the project via Texas Street will be provided through a two-way access road located midway between Pioneer Avenue and San Bernardino Avenue and connects to the internal roadway system of the project.

## **C.) San Bernardino Avenue**

San Bernardino Avenue, bordering the project to the south, has been designated as a major arterial in the General Plan. Six (6) lane divided major arterials have a modified design standard of one hundred twenty (120) foot right-of-way width, with one hundred four (104) foot curb-to-curb separation and six (6) foot wide sidewalks per the City's current Municipal Utilities and Engineering Department standard street widths. The modified design standard has no raised median along centerline and a twelve (12) foot shorter right-of-way width than the City's standard six (6) lane divided major arterial street section. To meet this standard additional right of way dedication and street improvements will be required along the property frontage on the north side of the street. San Bernardino Avenue will consist of six (6) traffic lanes and will function as a major traffic corridor in the future. Vehicular access to the project via San Bernardino will be provided through a two-way access road located midway between future New York Street and Texas Street and connects to the internal roadway system of the project. Traffic exiting the project site at this location will be restricted to a right turn only by a proposed raised median on San Bernardino Avenue at this site entry. A seven (7) foot wide pedestrian sidewalk is proposed along the north side of San Bernardino Avenue that will meander between the public right of way and adjacent landscape lot to be dedicated to the City.

## **D.) New York Street (Future)**

New York Street, bordering the project to the west, has been designated as a proposed collector street in the General Plan. Collector streets have a modified design standard of sixty-six (66) foot right-of-way width, with forty (44) foot curb-to-curb separation and five (5) foot wide sidewalks per the City's current Municipal Utilities and Engineering Department standard street widths. The modified design standard provides an additional four (4) feet of street width and has a two (2) foot wider right-of-way width than the City's standard residential collector street section. There is no existing right-of-way or improvements along New York Street between San Bernardino Avenue and Pioneer Avenue and the proposed alignment of the road is outside of the project boundary. Therefore, New York Street will be constructed in the future by the adjacent landowner. No vehicular access to the project is proposed along New York Street.

## **E.) Internal Circulation**

Access to the project is provided by two ingress/egress points, one on San Bernardino Avenue and one Texas Street. Internal roadways provide access to the residential units and parks planned for the development.

The street design section will be a modified City standard for local residential streets with a fifty-two (52) foot right-of-way width, thirty-six (36) foot curb-to-curb separation and six (6) foot wide curb adjacent sidewalks.

## **4.3 Infrastructure**

---

The Infrastructure Master Plan (Exhibit 4.2) designates the location and size of sewer, water and storm drainage lines throughout the specific plan area. Private utility lines, including gas, electricity, telephone, and cable TV are available locally, but are not shown on the plan. The sewer, water and storm drainage systems will be designed and constructed in accordance with plans reviewed and approved by the City of Redlands.

### **A.) Electrical and Natural Gas**

Southern California Edison will provide electricity to the Project. 12KV power lines currently exist along Texas Street, Pioneer Avenue and San Bernardino Avenue. In addition, a 66KV power line also runs along San Bernardino Avenue. Pursuant to the City of Redlands requirement to underground any power lines of 65KV or less, the Project will underground all three of the 12KV power lines. The 66KV power line along San Bernardino Avenue will remain on poles. The Project will connect to these service lines with the final configuration of these service lines to be approved by Southern California Edison. In addition, the entire Project will comply with Energy Building Regulations adopted by the California Energy Commission (Title 24 of the California Code of Regulations) and any adopted City of Redlands energy conservation requirements.

The Gas Company will supply natural gas service. The Project will connect to service lines with the final configuration to be approved by The Gas Company.

### **B.) Sewer**

The City of Redlands Municipal Utilities and Engineering Department (“MUED”) provides sewer service. There currently exists a 21” sewer line in San Bernardino Avenue and an eight-inch line in Texas Street. The Project will connect to the sewer line in San Bernardino Avenue with the final configuration to be approved by the City of Redlands MUED.

### **C.) Water**

The City of Redlands Municipal Utilities and Engineering Department (MUED) provides local water service in the City. There is currently an existing sixteen-inch potable water line in Pioneer Avenue, an eight-inch potable waterline in Texas Street, and a two-inch potable water line in San Bernardino Avenue.

The City of Redlands requires new residential uses to provide eight-inch potable water lines where appropriate. As such, the Project will be responsible for replacement of the existing two-inch waterline in San Bernardino Avenue with a minimum eight-inch system or twelve-inch system with reimbursement from the City for increased pipe capacity not required by the project. The internal project will be serviced by an eight-inch looped water system with connection to the water main lines in San Bernardino Avenue and Texas Street.

# Exhibit 4.2, Infrastructure Master Plan

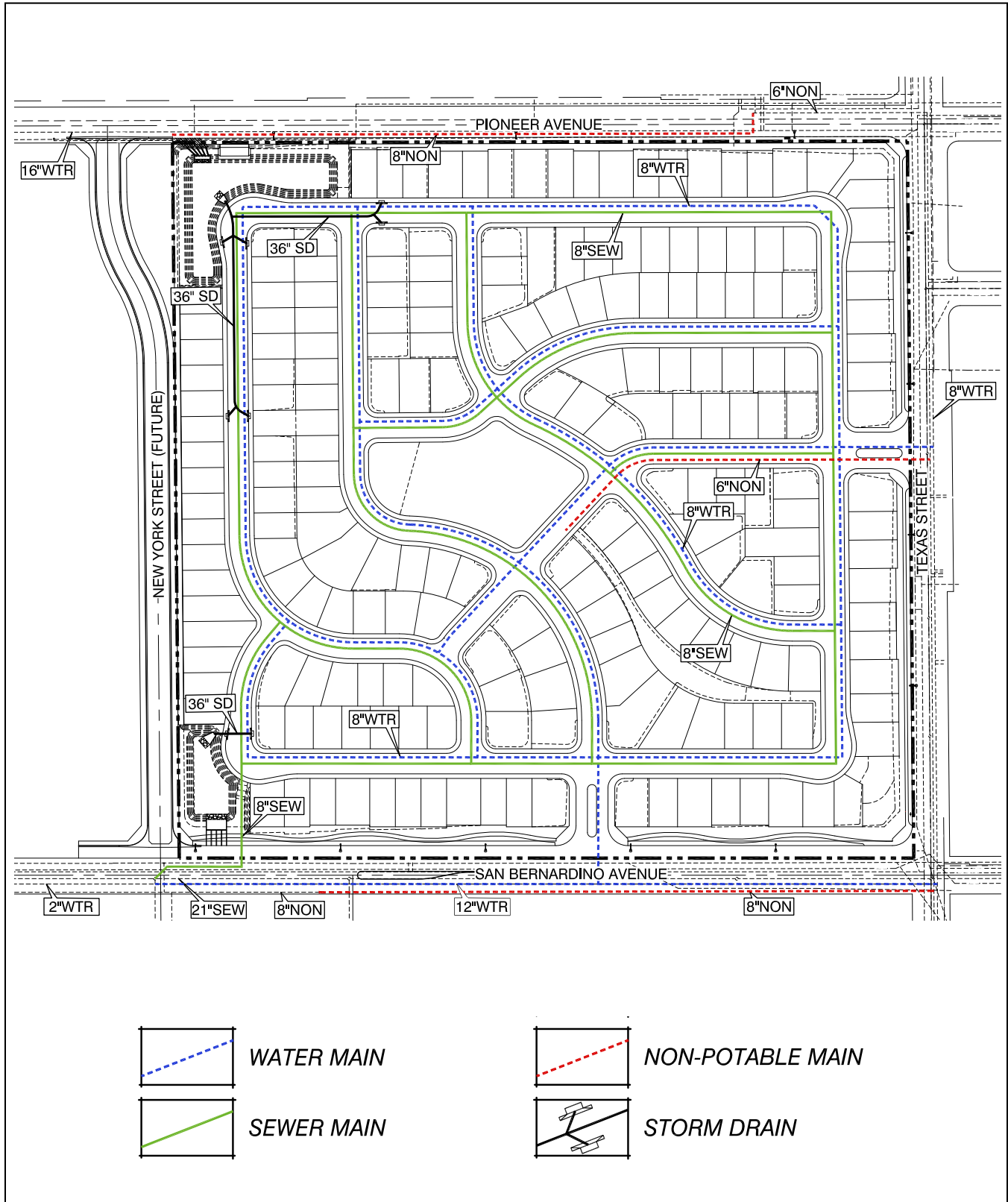

Source: Very Civil



There are existing non-potable waterlines in Pioneer Avenue, Texas Street and San Bernardino Avenue. If required by the City, these systems will be extended along the property frontage as shown on the project Infrastructure Exhibit. The extensions may include eight-inch non-potable waterlines in both Pioneer Avenue and San Bernardino Avenue.

An irrigation farming easement that connects the Project site to an existing well traverses the center of the property from east to west. If necessary, the Project will replace this line with a twelve-inch pipeline. The Project will also be responsible for the installation and upgrading of fire hydrants around the perimeter of the property pursuant to the City of Redlands Fire Department requirements.

## **D.) Storm Water Drainage**

Runoff from the project generally drains from east to west across the site in a sheet flow pattern and is diverted either north or south to adjacent streets by concrete irrigation channels that serviced the former site orchard. Pioneer Avenue and San Bernardino Avenue transmit runoff westerly to a trapezoidal concrete open channel running parallel to and along the east side of I-210. The channel, which is in Caltrans right-of-way, was constructed with the freeway in 1984 and drains to Reach 5 of the Santa Ana River.

The City of Redlands Drainage Master Plan (DMP) completed by RBF Consulting in 2014 and predecessor area drainage report CSDP#4 updated by the County of San Bernardino in 2013 provide the planned hydrology for the watershed where the project is located. Both studies utilize current general plan land use designations to determine run-off values for the areas being analyzed. For this project site, the future developed condition run-off values were based on a 'Commercial' land use designation. Based on the lower density development type proposed for the project (less than 6 dwelling units per acre), the drainage runoff from the site will be less than the values determined in the DMP.

The City's DMP also provides recommended storm drain improvements for the different subwatersheds included in the study. This project is in the "North City" subwatershed of the report that includes a recommendation for the installation of a storm drain system in San Bernardino Avenue extending from the I-210 channel to Texas Street along the project's southerly boundary. Although there are no current plans to construct this master planned facility, it is anticipated that adequate capacity will be provided in the storm drain system for the relatively small area of the project site that is proposed to drain to San Bernardino Avenue. The remainder of the project site is proposed to outlet in Pioneer Avenue along the northerly project limits.

Pioneer Avenue has a general plan street designation of 'Collector' and is anticipated to have adequate hydraulic capacity to convey run-off from the project site to the I-210 channel when fully widened. A detention facility is proposed at the project outlet onto Pioneer Avenue to mitigate increases in storm water run-off leaving the site. Drainage in Pioneer Avenue west of the project site travels along the southerly edge of the existing pavement in a shallow earthen channel that outlets into the I-210 channel. This drainage pattern will be maintained with the proposed development.

## **E.) Trails and Bike Routes**

The City of Redlands Bicycle Master Plan designates planned bikeways along the roads adjacent to the Specific Plan area. These future Class II bike lanes will expand the City's circulation network and allow for a connection to the future Santa Ana River Trail, north of the project site on Texas Street.

# 5

## IMPLEMENTATION

### 5.1 Purpose and Intent

---

The Heritage Specific Plan serves to implement the City's General Plan policies applicable to the project site and provide for orderly development of the project site. Tentative tract maps, once approved, shall establish the legal lots, public dedications, and easements within for the project.

Development within the Heritage Specific Plan shall be implemented through the City approval of tentative and final tract maps through the Development Plan Review process as established in the City of Redlands Municipal Code.

Unless otherwise provided, any ambiguity concerning the content or application of the Specific Plan shall be resolved by the City of Redlands Development Services Director, or his/her designee, in a manner consistent with the goals, policies, purpose and intent established in this Specific Plan.

### 5.2 Development Review Process

---

#### A.) Subdivision Maps

Approval of tentative subdivision map may occur concurrently with the adoption of the Specific Plan. All tentative and final subdivision maps shall be reviewed and approved pursuant to applicable provisions of the City of Redlands Subdivision Ordinance and consistent with the applicable provisions of the Land Use, Infrastructure, Design Guidelines, and Development Regulations adopted as part of this Specific Plan.

#### B.) Development Plan

All development within the confines of Specific Plan shall be subject to the Development Plan Review process as established in the City's Municipal Code. Pursuant to these provisions, Development Review Committee constitutes a design review of project architecture, site plans, landscape plans, and grading plans.

Adoption of the Specific Plan by the City includes adoption of the design guidelines contained within the Specific Plan which provide direction for the design of development within Heritage. Where the Specific Plan development regulations and design guidelines are silent, the applicable development regulations and design guidelines contained within the City's Municipal Code shall apply.

The design guidelines are intended to be flexible in nature while establishing basic evaluation criteria for the review of development projects by the City.

## **C.) Development Agreement**

If deemed necessary, approval of a statutory Development Agreement, authorized pursuant to California Government Code Sections 65864 et seq., may be used in part of the approval of the Specific Plan and prior to approval of the first Final Map.

The Development Agreement shall include, but not be limited to, methods for financing, acquisition, and construction of infrastructure. If required, the Heritage Development Agreement shall be fully executed prior to the issuance of the first building permits for the project.

## **5.3 Specific Plan Modifications and Amendments**

---

### **A.) Minor Modifications**

All minor modifications will be subject to the City of Redlands Municipal Code. The following constitute minor modifications to the Specific Plan, and do not require a Specific Plan Amendment.

- Change in utility and/or public service provider.
- Collector roadway alignment when the change results in a center line shift of less than 250 feet.
- An increase of up to ten percent (10%) in square footage of floor area provided the total square footage of floor area number for the entire Specific Plan area does not exceed that established by this Specific Plan.
- Minor changes to landscape materials, wall materials, wall alignment, entry design, and streetscape design which are consistent with the conceptual design set forth in the design guidelines contained within the Specific Plan.
- Minor changes to the design guidelines, which are intended to be conceptual in nature, and are intended to be flexible in implementation.
- Minor changes of any quantifiable development standard or design guideline.
- Other modifications of a similar nature to those listed above which are in keeping with the purpose and intent of the approved Specific Plan and which are in conformance with the General Plan.

### **B.) Specific Plan Amendments**

Amendments to the Specific Plan may be requested by the applicant or the City pursuant to Section 65453(a) of the Government Code. Amendments shall be processed pursuant to the provisions of the Government Code for Specific Plan Amendments.



In the event that the proposed amendment requires supplemental environmental analysis pursuant to the California Environmental Quality Act (CEQA), the applicant is responsible for preparing the necessary CEQA documentation.

## **5.4 Variances**

---

Variances and administrative exceptions to the development regulations contained in the Specific Plan with respect to landscaping, screening, site area, site dimensions, yards and projects into yards, heights of structures, distances between buildings, open space and off-street parking and loading shall be reviewed pursuant to the City of Redlands Municipal Code.

## **5.5 Program of Implementation Measures**

---

The project is not expected to significantly impact or result in a need for new public services provided by the City of Redlands, the Redlands Unified School District, or other governmental agencies. Any impacts associated with this development shall be mitigated with the payment of established development impact and school fees.

The City's Development Fee Policy is outlined in Principle One under Section 1A.0 (Principles of Managed Development) of the General Plan. Principle One states that "the cost of infrastructure required to mitigate the effects of new development shall be paid by that new development." The City of Redlands has established water, sewer, and solid waste development impact fees for single family residential developments that must be paid by the developer to cover the cost of the new public infrastructure.

Required public improvements for the project including water, sewer, and street improvements will be installed with the development of the subdivision, in accordance with the State Subdivision Map Act, the City's Subdivision Ordinance, the Subdivision Improvement Agreement for the project, and prior to final approval of a building permit for any home (up to three model homes). In addition, to ensure construction of the required public improvements, the subdivision will be required to furnish improvements security, such as a bond, as a guarantee of performance.

A Homeowner's Association shall be established through Conditions, Covenants, and Restrictions (CC&R's) for the perpetual maintenance of landscaping and common areas. The CC&R's shall be reviewed and approved by the City of Redlands prior to recordation.

# Exhibit 5.1, Tentative Tract Map

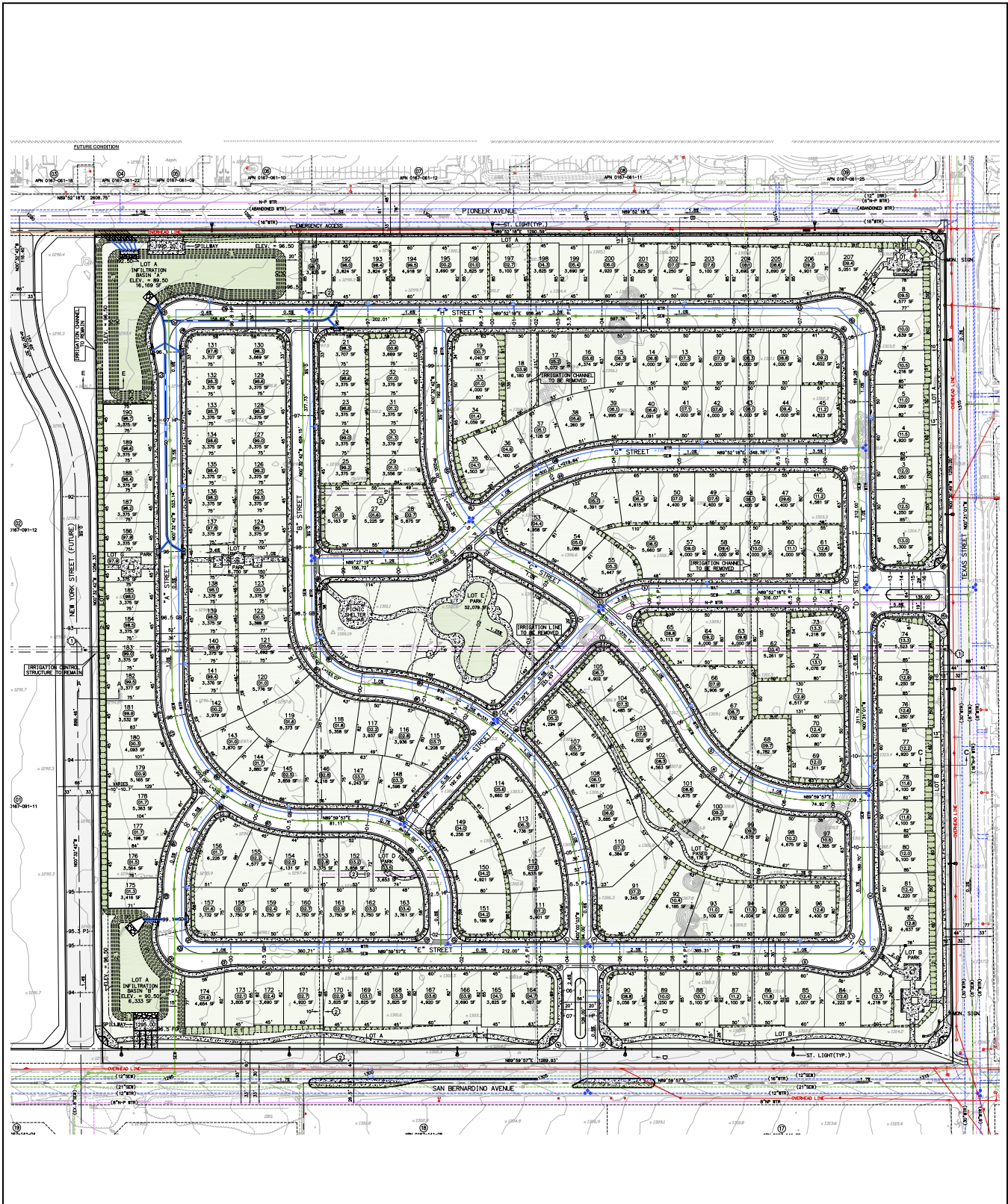

Source: Very Civil



## 5.6 General Plan Consistency

---

The following Guiding Policies and Implementing Policies of the General Plan are relevant to the Heritage Specific Plan:

- **2-P.1** - Embrace the unique identities of individual neighborhoods in Redlands and encourage the celebration and enhancement of characteristics that make each neighborhood distinct.
- **2-P.3** - Promote planning practices that mitigate the presence of physical barriers between communities (i.e. freeways) and foster greater connections between neighborhoods and uses.
- **2-A.4** - Maintain continuity in streetscape design along major streets and avenues that traverse north and south – California, Nevada, Alabama, Tennessee, Orange, Church, University, Judson, and Wabash; and those that traverse east and west – Pioneer, San Bernardino, Lugonia, Redlands Boulevard, and Citrus.
- **2-A.14** - Use development standards to ensure smooth transitions for neighborhoods that border one another so that neighborhoods maintain their unique qualities while being compatible with one another.
- **4-P.16** - Promote a variety of housing types to serve the diverse needs of the community.
- **4-A.7** - Promote a range of residential densities to encourage a mix of housing types in varying price ranges and rental rates.
- **4-A.8** - Promote the development of a greater variety of housing types, including single-family homes on small lots, accessory dwelling units, townhomes, lofts, live-work spaces, and senior and student housing to meet the needs of future demographics and changing family sizes.
- **7-P.1** - Promote active lifestyles and community health by furthering access to trails, parks, public open space, and other recreational opportunities.
- **7-A.35** - Implement street design features that facilitate walking and biking in both new and established areas. Require a minimum standard of these features for all new developments.

This page is intentionally left blank.



**Heritage  
Specific Plan**

September 2019  
City of Redlands, CA

