

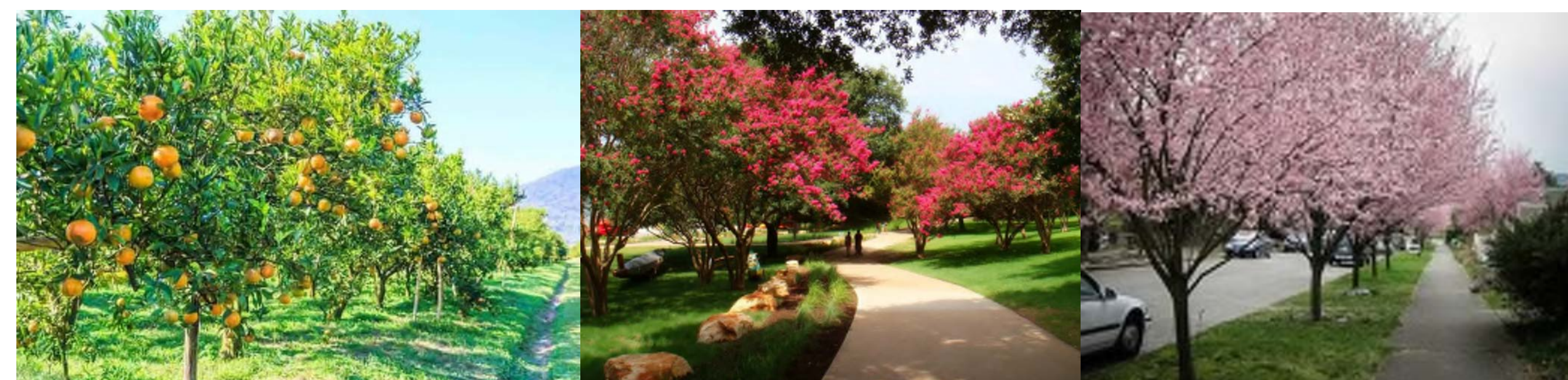

HOA LANDSCAPE BUFFER AND PARK PLANTING LEGEND				
TREES	BOTANICAL NAME	COMMON NAME	SIZE	WUCOLS
	Citrus Spp	Citrus Tree	24" BOX	M
	Quercus lobata	Valley Oak	24" BOX	M
	Lagerstroemia indica Prunus cerasifera	Catawba Crape Myrtle Cherry Plum Tree	24" BOX	M
	Platanus racemosa	California Sycamore	24" BOX	M
	Platanus x acerifolia 'Columbia'	Columbia London Plane Tree	24" BOX	M
	Pinus eldarica	Afghan Pine	24" BOX	L
	Arbutus unedo 'Marina'	Strawberry Tree	24" BOX	L
	Quercus virginiana	Southern Live Oak	24" BOX	M

DESIGN INTENT

TO CREATE A SPACE THAT HARMONIZES WITH THE LOCAL LANDSCAPE AND ACKNOWLEDGES THE HISTORY. THE SHAPES AND FORMS ARE INSPIRED BY THE SURROUNDING LANDSCAPE OF THE REDLANDS AND SAN BERNARDINO MOUNTAINS. THE WINGED TYPE GEOMETRIC SHAPES ARE INSPIRED BY THE LOCAL REDLANDS AIRPORT NEARBY. THE LINEAR GROVES PAY TRIBUTE TO THE CITRUS HISTORY OF REDLANDS. AS WITH THE FORMS, THE PLAY STRUCTURE AND COLOR TAKE THE LOCAL MOUNTAIN RANGES THE HIGHS, LOWS AND LAYERING. ORANGE ACCENT COLORS REPRESENT THE REDLANDS CITRUS INDUSTRY WHICH WAS ONE OF THE STRONGEST PRODUCERS IN THE REGION FOR OVER 75 YEARS.



LANDSCAPE BUFFER CHARACTER



ENTRY CHARACTER

CITRUS ESTATES



310 NORTH JOY STREET | CORONA, CA 92879
T: 951.737.1124 | F: 951.737.6551

OVERALL SITE

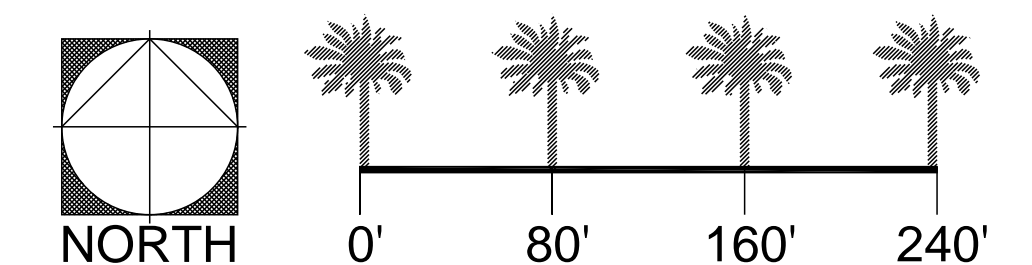

CONCEPTUAL LANDSCAPE PLAN

PREPARED FOR: PULTE GROUP
27401 LOS ALTOS, SUITE 400 MISSION VIEJO, CA 92691

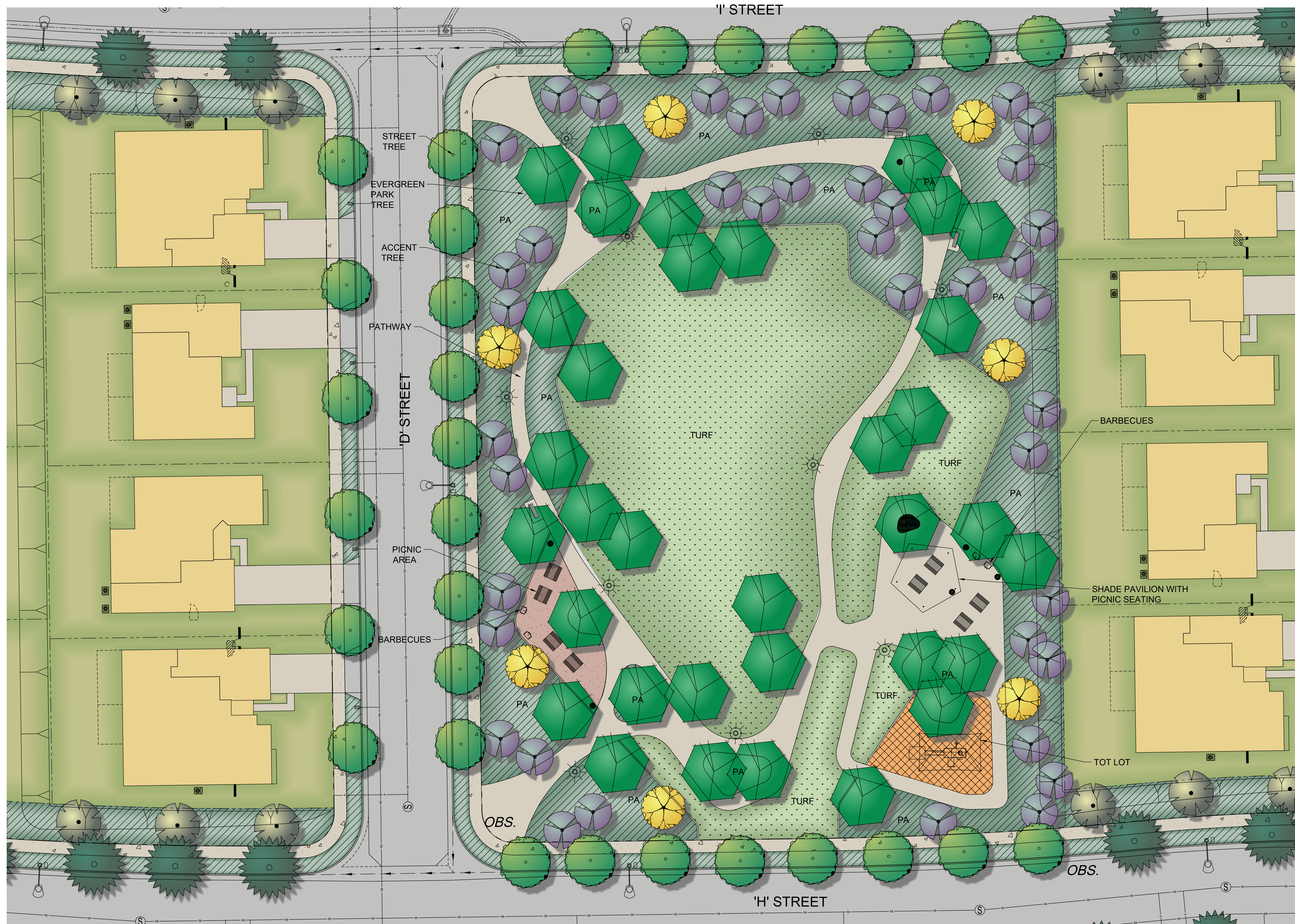

HOA LANDSCAPE BUFFER AND PARK PLANTING LEGEND				
TREES	BOTANICAL NAME	COMMON NAME	SIZE	WUCOLS
	Citrus Spp	Citrus Tree	24" BOX	M
	Quercus lobata	Valley Oak	24" BOX	M
	Lagerstroemia indica "Catawba" Prunus cerasifera	Catawba Crape Myrtle Cherry Plum Tree	24" BOX	M
	Platanus racemosa	California Sycamore	24" BOX	M
	Platanus x acerifolia "Columbia"	Columbia London Plane Tree	24" BOX	M
	Pinus eldarica	Afghan Pine	24" BOX	L
	Arbutus unedo "Marina"	Strawberry Tree	24" BOX	L
	Quercus virginiana	Southern Live Oak	24" BOX	M
ACCENT SHRUBS	BOTANICAL NAME	COMMON NAME	SIZE	WUCOLS
	Salvia leucantha	Santa Barbara Sage	1 Gal	L
	Westringia fruticosa Mundi	Low Coast Rosemary	5 Gal	L
	Rosa x 'Noare'	Flower Carpet® Red Groundcover Rose	5 Gal	L
	Salvia greggii	Autumn Sage	1 Gal	L
	Rosmarinus officinalis	Rosemary	5 Gal	L
BACKGROUND/ SCREENING SHRUBS	BOTANICAL NAME	COMMON NAME	SIZE	WUCOLS
	Leucophyllum frutescens "Compacta"	Compact Texas Ranger	5 Gal	L
	Pittosporum tobira "Variegata"	Variegated Pittosporum	5 Gal	L
	Rhaphiolepis indica "Spring Time"	Springtime Indian Hawthorn	5 Gal	M
SPREADING GROUNDCOVERS	BOTANICAL NAME	COMMON NAME	SIZE	WUCOLS
	Baccharis pilularis "Twin Peaks"	Twin Peaks Coyote Brush	1 Gal	L
	Myoporum parvifolium	Creeping Myoporum	1 Gal	L
	Ceanothus griseus var. horizontalis	Carmel Creeper Ceanothus	1 Gal	L
	Cotoneaster horizontalis	Rockspray	1 Gal	M
VINES	BOTANICAL NAME	COMMON NAME	SIZE	WUCOLS
	Ficus pumila	Creeping Fig	5 Gal	L
TURF SCHEDULE	BOTANICAL NAME	COMMON NAME		
	Cynodon dactylon	Common Bermuda		

ALL SHRUB AND GROUNDCOVER AREAS TO RECEIVE 3" MEDIUM GRIND BARK MULCH

CITRUS ESTATES



310 NORTH JOY STREET | CORONA, CA 92879
T: 951.737.1124 | F: 951.737.6551

PARK ENLARGEMENT

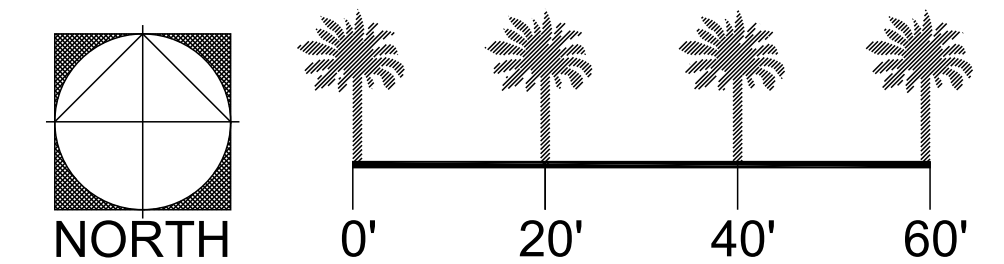

CONCEPTUAL LANDSCAPE PLAN

PREPARED FOR: PULTE GROUP
27401 LOS ALTOS, SUITE 400 MISSION VIEJO, CA 92691

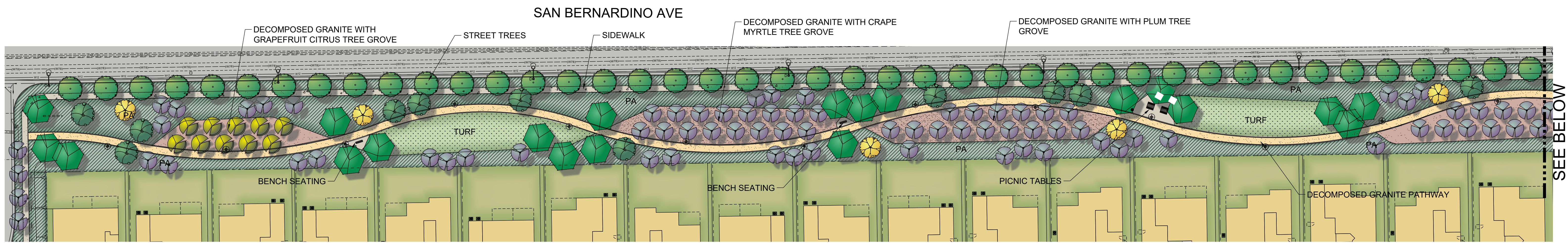

HOA LANDSCAPE BUFFER AND PARK PLANTING LEGEND				
TREES	BOTANICAL NAME	COMMON NAME	SIZE	WUCOLS
	Citrus Spp	Citrus Tree	24" BOX	M
	Quercus lobata	Valley Oak	24" BOX	M
	Lagerstroemia indica "Catawba" Prunus cerasifera	Catawba Crape Myrtle Cherry Plum Tree	24" BOX	M
	Platanus racemosa	California Sycamore	24" BOX	M
	Platanus x acerifolia "Columbia"	Columbia London Plane Tree	24" BOX	M
	Pinus eldarica	Alghan Pine	24" BOX	L
	Arbutus unedo 'Marina'	Strawberry Tree	24" BOX	L
	Quercus virginiana	Southern Live Oak	24" BOX	M

ACCENT SHRUBS	BOTANICAL NAME	COMMON NAME	SIZE	WUCOLS
	Salvia leucantha	Santa Barbara Sage	1 Gal	L
	Westringia fruticosa Mundi	Low Coast Rosemary	5 Gal	L
	Rosa x 'Noare'	Flower Carpet® Red Groundcover Rose	5 Gal	L
	Salvia greggii	Autumn Sage	1 Gal	L
	Rosmarium officinalis	Rosemary	5 Gal	L
BACKGROUND/SCREENING SHRUBS	BOTANICAL NAME	COMMON NAME	SIZE	WUCOLS
	Leucophyllum frutescens 'Compacta'	Compact Texas Ranger	5 Gal	L
	Pittosporum tobira 'Variegata'	Variegated Pittosporum	5 Gal	L
	Raphiolepis indica 'Spring Time'	Springtime Indian Hawthorn	5 Gal	M
SPREADING GROUNDCOVERS	BOTANICAL NAME	COMMON NAME	SIZE	WUCOLS
	Baccharis pilularis 'Twin Peaks'	Twin Peaks Coyote Brush	1 Gal	L
	Myoporum parvifolium	Creeping Myoporum	1 Gal	L
	Ceanothus griseus var. horizontalis	Carmel Creeper Ceanothus	1 Gal	L
	Cotoneaster horizontalis	Rockspray	1 Gal	M
VINES	BOTANICAL NAME	COMMON NAME	SIZE	WUCOLS
	Ficus pumila	Creeping Fig	5 Gal	L
TURF SCHEDULE	BOTANICAL NAME	COMMON NAME		
	Cynodon dactylon	Common Bermuda		

ALL SHRUB AND GROUNDCOVER AREAS TO RECEIVE 3" MEDIUM GRIND BARK MULCH

CITRUS ESTATES

TYPICAL LANDSCAPE BUFFER

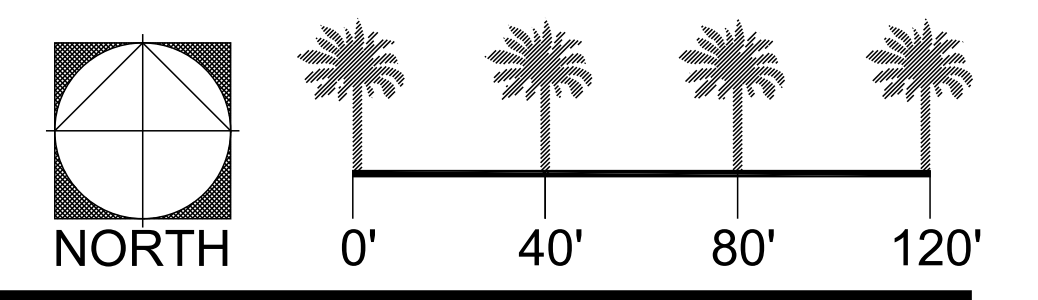

310 NORTH JOY STREET | CORONA, CA 92879
T: 951.737.1124 | F: 951.737.6551

CONCEPTUAL LANDSCAPE PLAN

PREPARED FOR: PULTE GROUP
27401 LOS ALTOS, SUITE 400 MISSION VIEJO, CA 92691

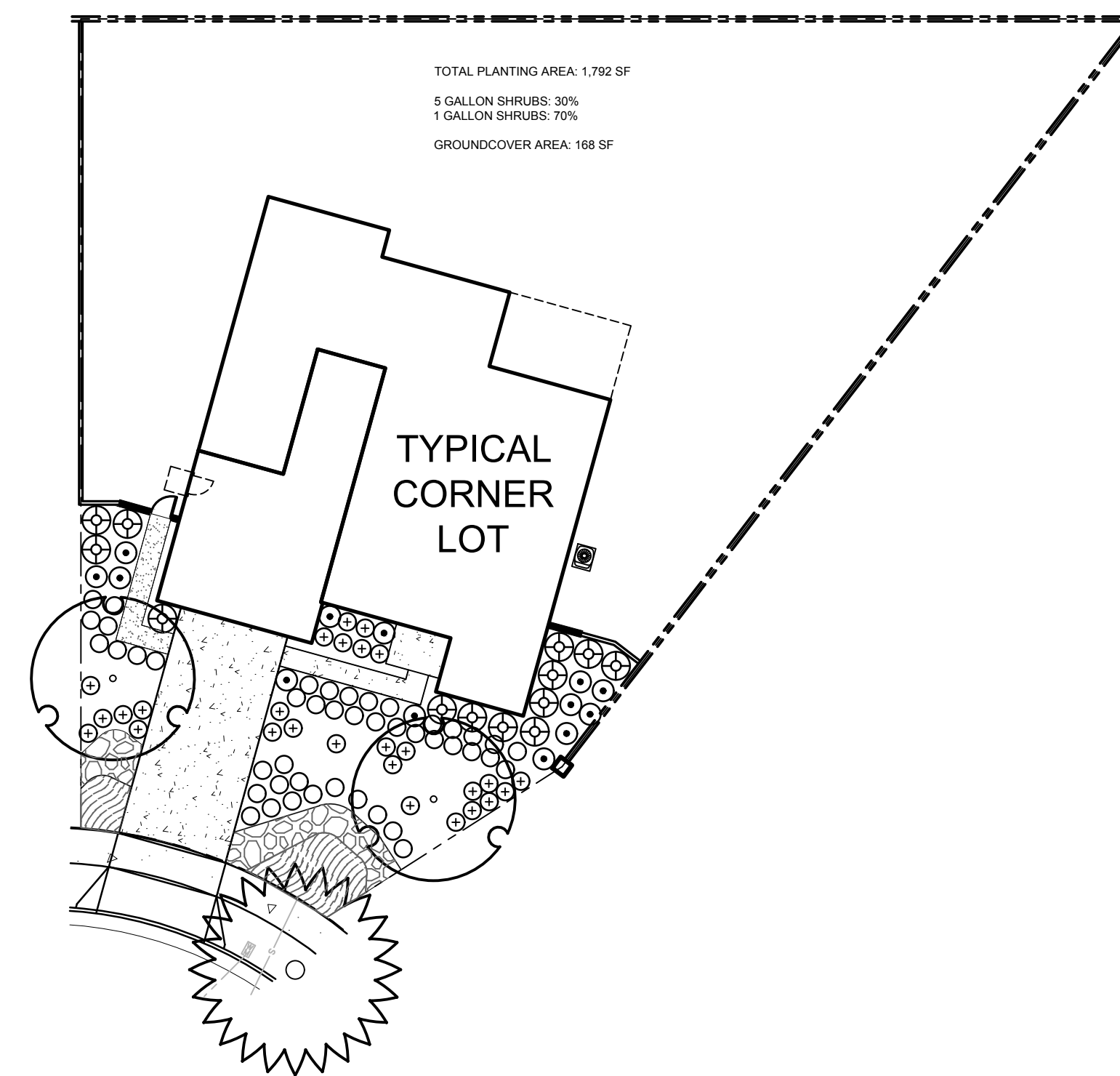
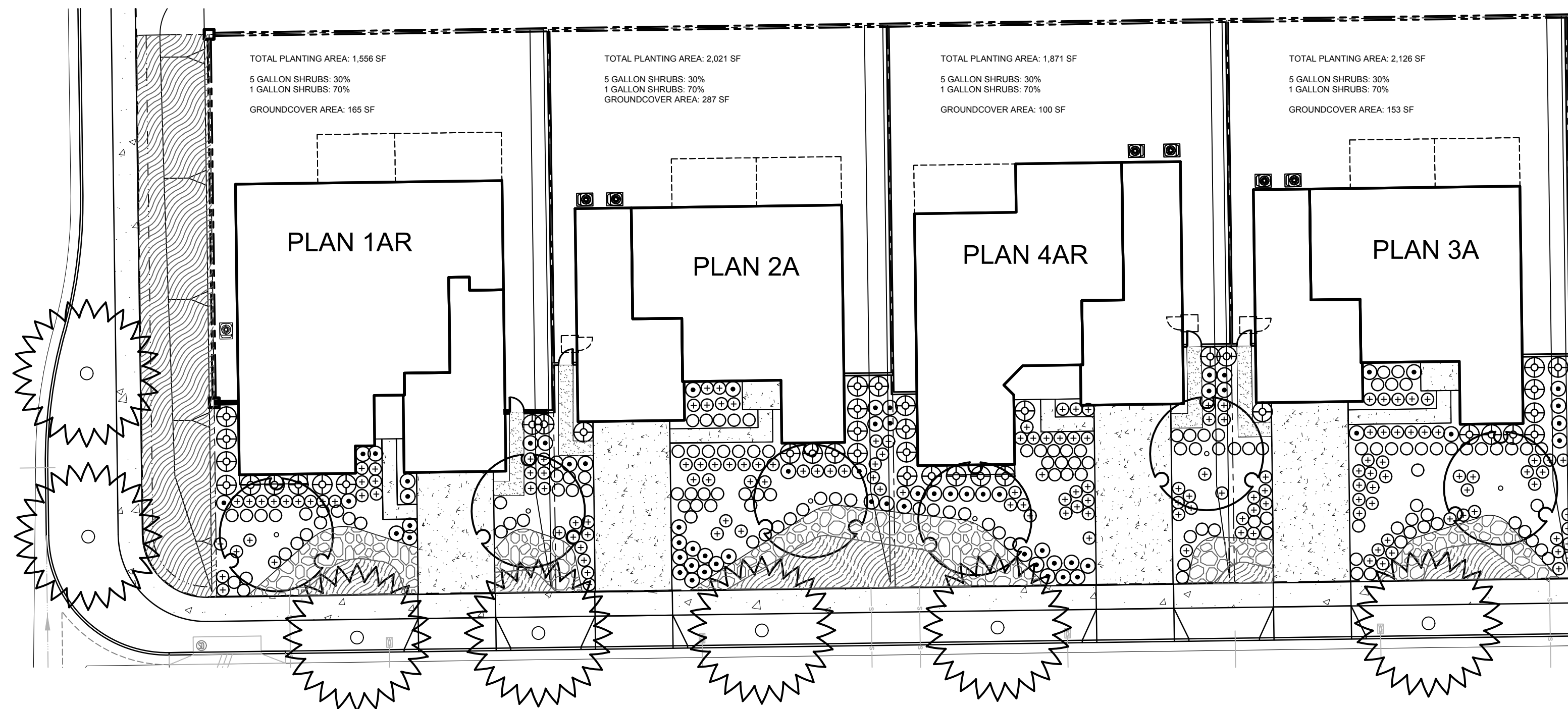

TYPICAL FRONT YARD TREE LEGEND				
SYMBOL	SCIENTIFIC NAME	COMMON NAME	SIZE	WUCOLS
	<i>Arbutus x 'Marina'</i>	Marina Strawberry Tree	15 Gal	L
	<i>Chitalpa tashkentensis 'Pink Dawn'</i>	Pink Dawn Chitalpa	15 Gal	L
	<i>Rhus lancea</i>	African Sumac	15 Gal	L
	Street Tree	Refer to Street Tree Legend		

FRONT YARD SHRUB LEGEND				
	SCIENTIFIC NAME	COMMON NAME	SIZE	WUCOLS
BACKGROUND SHRUBS				
	<i>Leucophyllum frutescens 'Green Cloud'</i>	Green Cloud Texas Ranger	5 Gal	L
	<i>Strelitzia juncea</i>	Narrow-Leaved Bird of Paradise	5 Gal	L
	<i>Panicum virgatum 'Heavy Metal'</i>	Heavy Metal Blue Switch Grass	5 Gal	L
MID-GROUND SHRUBS				
	<i>Salvia greggii</i>	Autumn Sage	5 Gal	L
	<i>Bougainvillea 'Monka'</i>	Bougainvillea	5 Gal	L
	<i>Leymus condensatus 'Canyon Prince'</i>	Canyon Prince Wild Rye	5 Gal	L
FOREGROUND SHRUBS				
	<i>Lavandula x intermedia 'Provence'</i>	Provence French Lavender	1 Gal	L
	<i>Anigozanthus flavidus 'Bush Blaze'</i>	Bush Blaze Kangaroo Paw	1 Gal	L
	<i>Bouteloua gracilis 'Blonde Ambition'</i>	Blond Ambition Blue Grama Grass	1 Gal	L
ACCENT SHRUBS				
	<i>Salvia leucantha 'Santa Barbara'</i>	Santa Barbara Sage	5 Gal	L
	<i>Hesperaloe parviflora 'Brakelights'</i>	Brakelights Red Yucca	5 Gal	L
	<i>Muhlenbergia capillaris 'Lenca'</i>	Pink Muhly	5 Gal	L
GROUNDCOVERS				
	<i>Rosmarinus officinalis 'Prostratus'</i>	Prostrate Rosemary	Flats @ 18" O.C.	L
	<i>Myoporum parvifolium 'Pink'</i>	Pink Racer Prostrate Myoporum	Flats @ 18" O.C.	L
	<i>Carex pansa</i>	California Meadow Sedge	Flats @ 12" O.C.	L
1'-3" ROCK COBBLE ACCENT				
3/8" MINUS DECOMPOSED GRANITE				

ALL SHRUB AND GROUND COVER AREAS TO RECEIVE 3" MEDIUM GRIND BARK MULCH

CITRUS ESTATES



310 NORTH JOY STREET | CORONA, CA 92879
 T: 951.737.1124 | F: 951.737.6551

TYPICAL FRONT YARDS

CONCEPTUAL LANDSCAPE PLAN

PREPARED FOR: PULTE GROUP
 27401 LOS ALTOS, SUITE 400 MISSION VIEJO, CA 92691

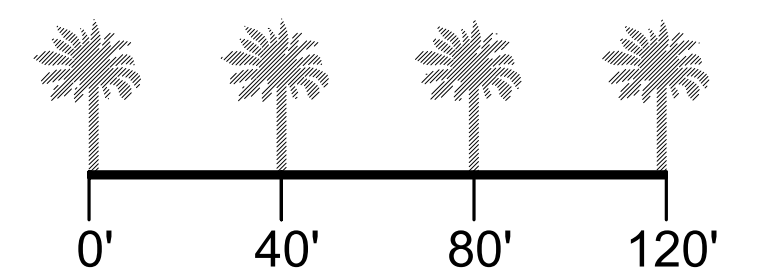

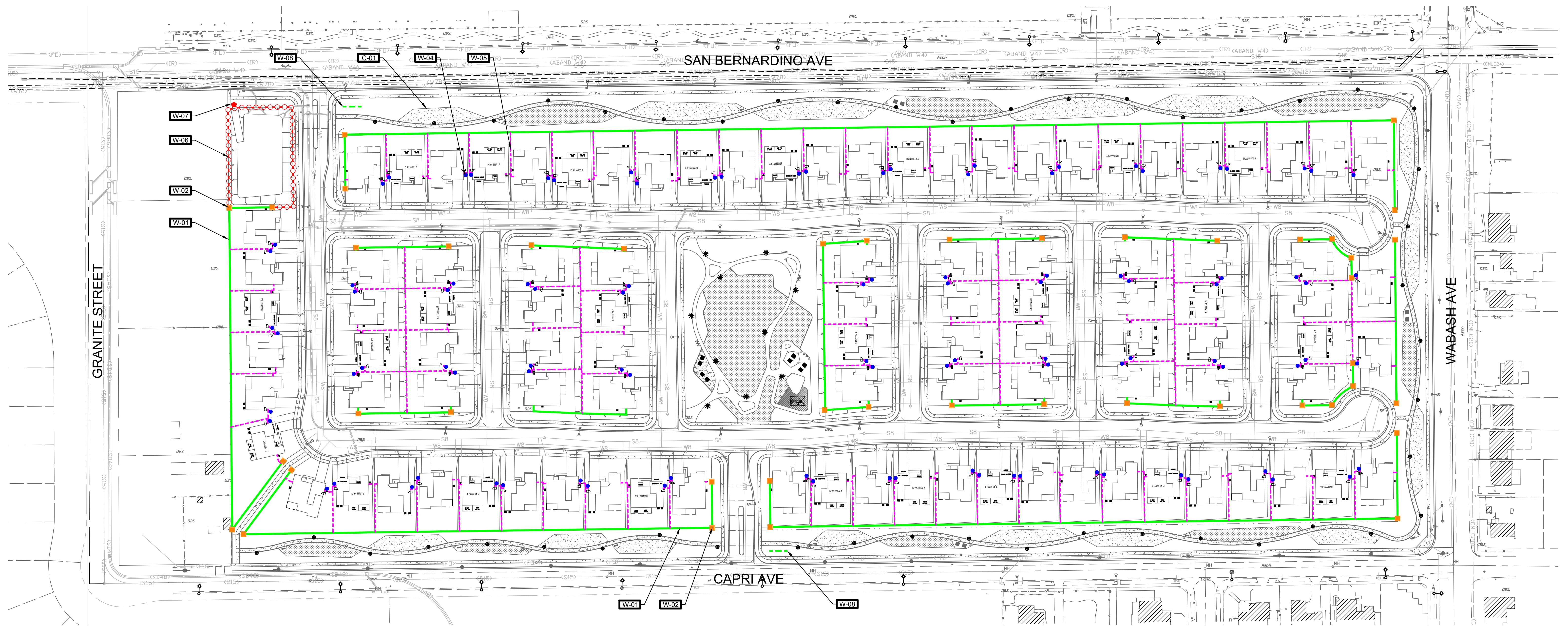

WALL AND FENCE LEGEND	
CODE/SYMBOL	DESCRIPTION
W-01 	6'-0" TALL SPLIT-FACE BLOCK WALL W/ PRECISION BLOCK CAP
W-02 	6'-6" TALL SPLIT-FACE BLOCK PILASTER W/ PRECISION BLOCK CAP
W-03 	6'-6" TALL INTERMEDIATE SPLIT-FACE BLOCK PILASTER W/ PRECISION BLOCK CAP
W-04 	6'-0" TALL INTERIOR VINYL FENCE, COLOR WHITE
W-05 	3'-0" WIDE VINYL GATE, COLOR WHITE
W-06 	6'-0" TALL TUBULAR STEEL FENCE
W-07 	6'-0" TALL TUBULAR STEEL MAINTENANCE GATE
W-08 	42" TALL PROJECT ENTRY MONUMENT WALL
C-01 	6" WIDE CONCRETE MOW CURB

WALL AND FENCE ELEVATIONS

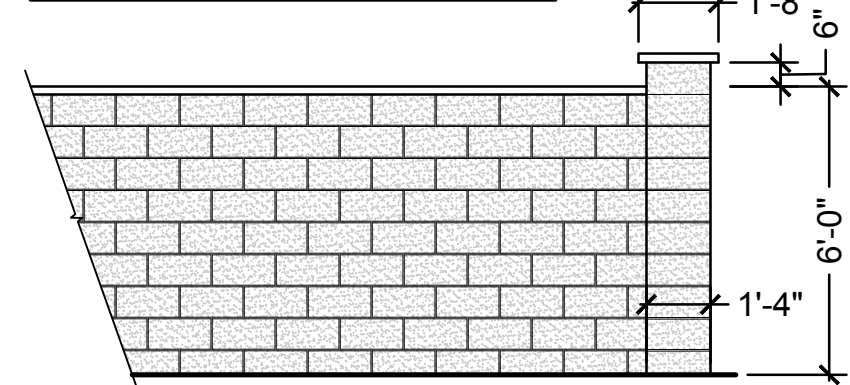

WALL: W-01
PILASTER: W-02, W-03
6'-0" TALL SPLIT-FACE BLOCK WALL W/ PRECISION BLOCK CAP

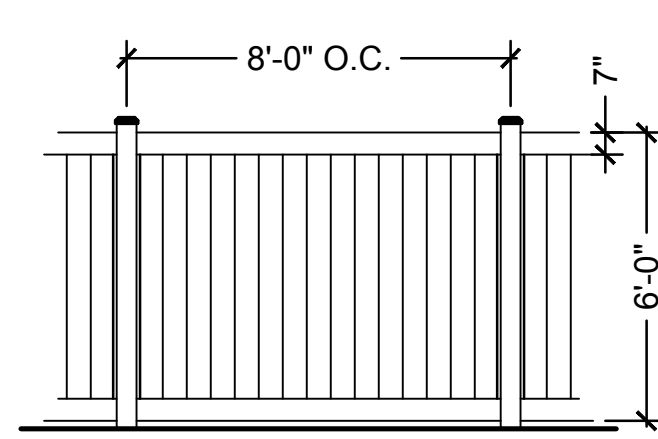

FENCE: W-04
6'-0" TALL INTERIOR VINYL FENCE, COLOR WHITE

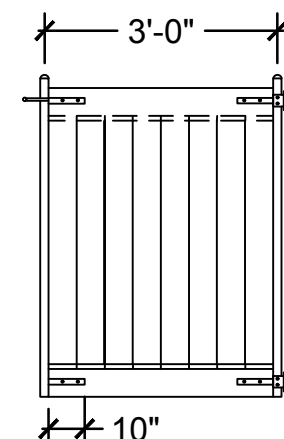

GATE: W-05
3'-0" WIDE VINYL GATE, COLOR WHITE

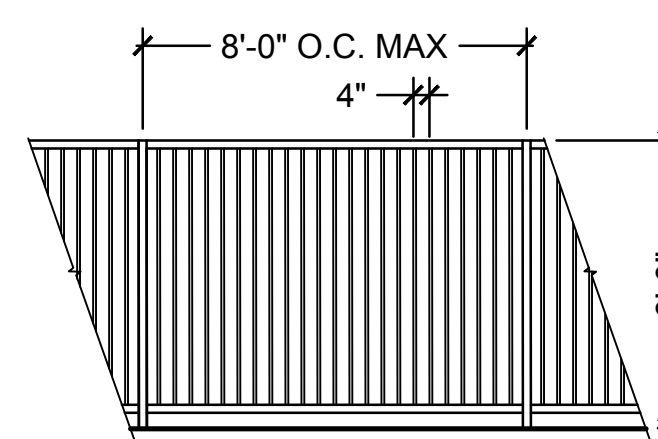

FENCE: W-06
6'-0" TALL TUBULAR STEEL VIEW FENCE

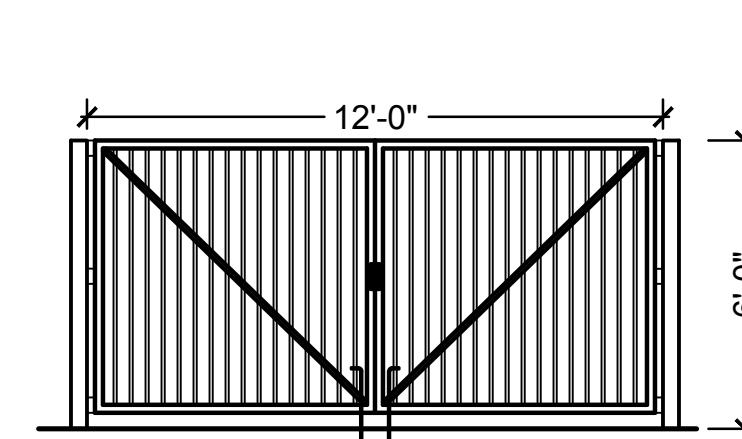

GATE: W-07
6'-0" TALL TUBULAR STEEL MAINTENANCE GATE

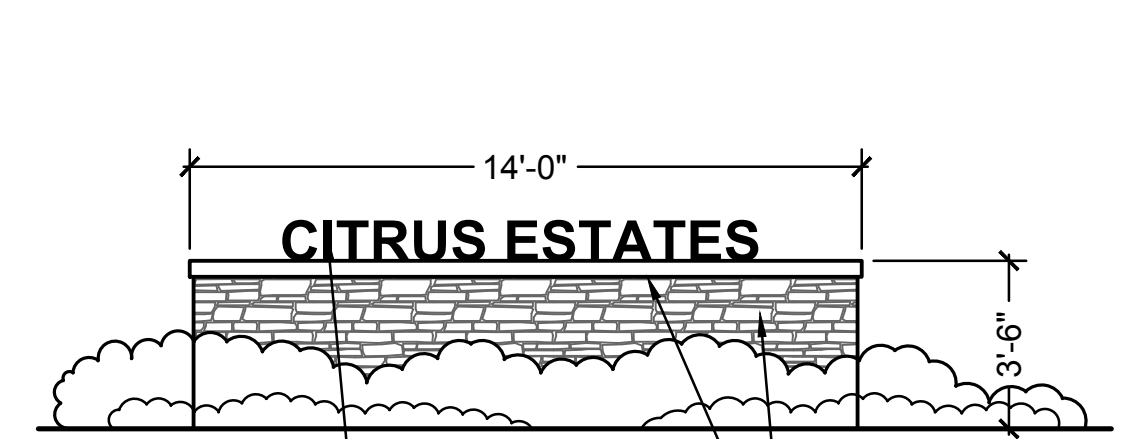

WALL: W-08
42" TALL ENTRY MONUMENT WALL
PIN SET LETTERING
STONE VENEER WALL
PRECISION CAP

CITRUS ESTATES



310 NORTH JOY STREET | CORONA, CA 92879
T: 951.737.1124 | F: 951.737.6551

WALL AND FENCE PLAN

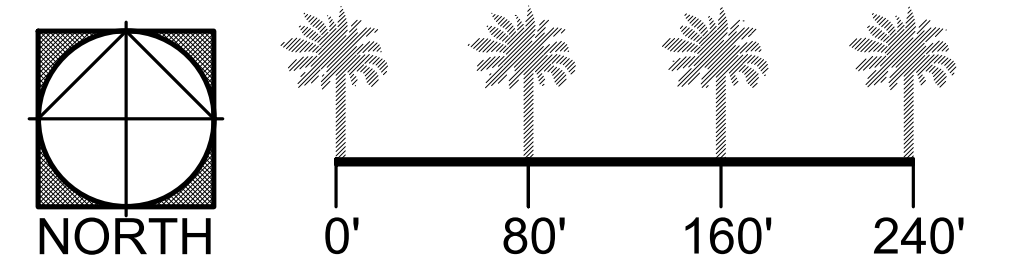

CONCEPTUAL LANDSCAPE PLAN

PREPARED FOR: PULTE GROUP
27401 LOS ALTOS, SUITE 400 MISSION VIEJO, CA 92691



BY POLIGON SHADE STRUCTURES
 32' HEXAGON STEEL SHADE STRUCTURE
 COLORS: POSTS - HUNTER GREEN
 ROOF - TUDOR BROWN



BY DOGI POT
 DOGIPOT PET STATION
 COLOR: GREEN



BY FIRE MAGIC
 POST MOUNT FIRE MAGIC CHARCOAL
 COLOR: STAINLESS



BY LANDSCAPE FORMS
 AUSTIN BENCH BACKED
 COLOR: FLAMBE ORANGE

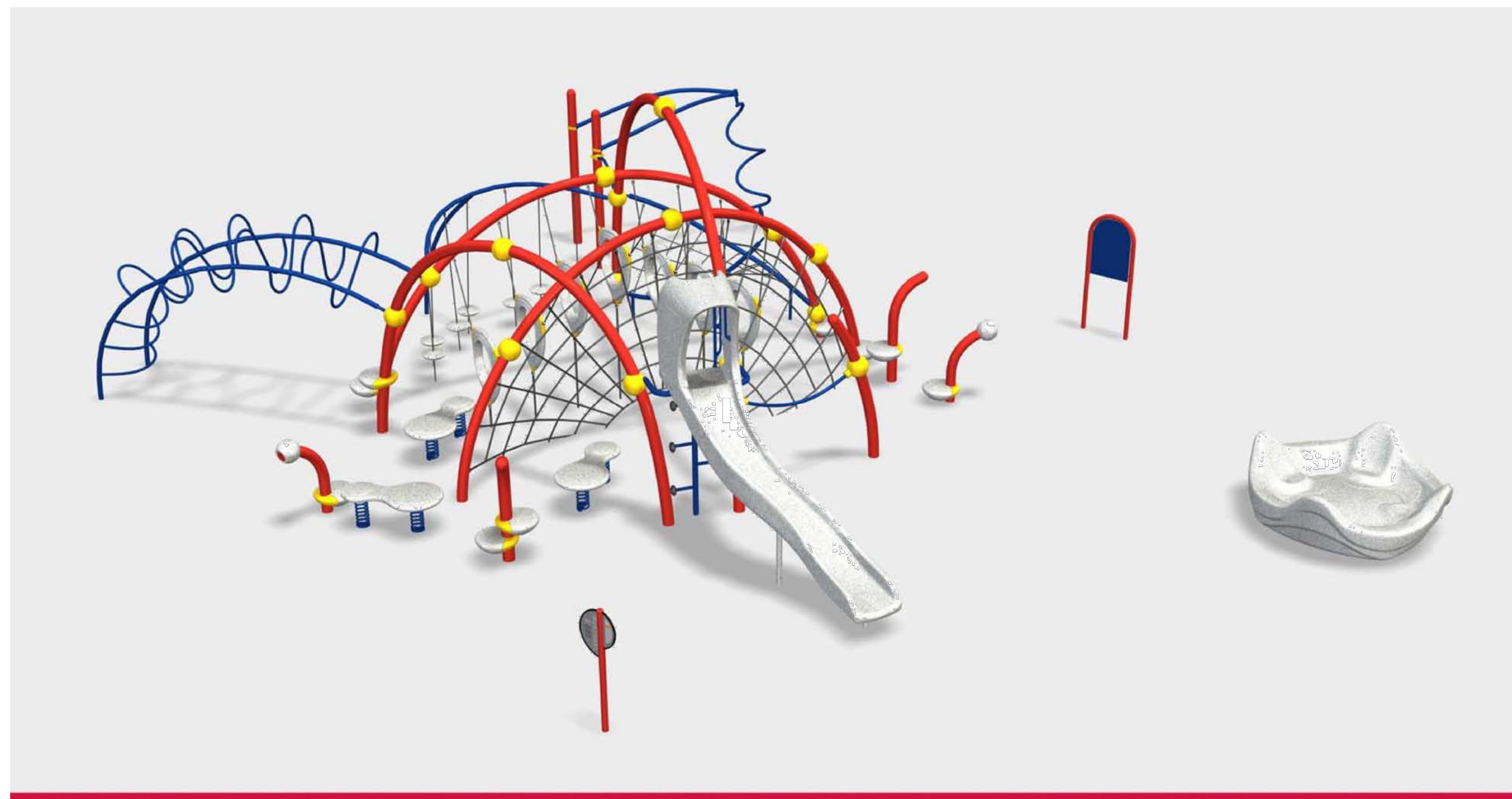

BY LANDSCAPE STRUCTURES
 PLAY STRUCTURE: EVOS
 COLORS: ORANGE, BLUE AND WHITE



BY QUICK CRETE PRODUCTS (QCP)
 HOT ASH RECEPTACLE
 COLOR: LATTE
 FINISH: CRAFTSMAN ETCH



BY LANDSCAPE FORMS
 MULTIPLICITY TABLE AND BENCH
 COLOR: FLAMBE ORANGE



BY LANDSCAPE FORMS
 MULTIPLICITY LITTER
 COLOR: GRASS

CITRUS ESTATES



310 NORTH JOY STREET | CORONA, CA 92879
 T: 951.737.1124 | F: 951.737.6551

SITE AMENITIES

CONCEPTUAL LANDSCAPE PLAN

PREPARED FOR: PULTE GROUP
 27401 LOS ALTOS, SUITE 400 MISSION VIEJO, CA 92691



ENTRY CHARACTER



NEIGHBORHOOD PARK CHARACTER



LANDSCAPE BUFFER CHARACTER

CITRUS ESTATES



310 NORTH JOY STREET | CORONA, CA 92879
T: 951.737.1124 | F: 951.737.6551

INSPIRATIONAL IMAGERY
CONCEPTUAL LANDSCAPE PLAN

PREPARED FOR: PULTE GROUP
27401 LOS ALTOS, SUITE 400 MISSION VIEJO, CA 92691



HOA LANDSCAPE BUFFER AND PARK TREES



ACCENT AND SCREEN SHRUBS AND GROUNDCOVERS



ACCENT AND SCREEN SHRUBS AND GROUNDCOVERS

CITRUS ESTATES



310 NORTH JOY STREET | CORONA, CA 92879
 T: 951.737.1124 | F: 951.737.6551

PLANTING IMAGERY CONCEPTUAL LANDSCAPE PLAN

PREPARED FOR: PULTE GROUP
 27401 LOS ALTOS, SUITE 400 MISSION VIEJO, CA 92691